

E8

Heating Controller

Operating and Installation Instructions



Please observe the safety instructions and read through this manual carefully before commissioning the equipment.

Safety information

Power connection regulations

Please note the connection conditions specified by your local electrical power supply company and the VDE regulations. Your heating control system may only be installed and serviced by appropriately authorised specialists.

- △ For fixed devices, a facility for mains disconnection in accordance with EN 60335 must be installed in compliance with the installation specifications (e.g. switch).
- △ The mains lines insulation must be protected against damage caused by overheating (e.g. insulation hose).
- △ The minimum distance to installation objects in the vicinity must be chosen so that the permitted ambient temperature is not exceeded during operation (see table - Technical Data).
- △ If the system is not installed properly, persons using it are at put at risk of fatal or serious injury (electric shock).
Ensure the controller is de-energized prior to performing any work on the controller!

Warranty conditions

If the system is not installed, commissioned, serviced and repaired properly, it will render the manufacturer's warranty null and void.

Important text passages

! Important notes are denoted by an exclamation mark.

- △ This attention symbol is used to point out dangers in this manual.

Installation

Notes on installation and commissioning and a connection plan can be found in part 4 of this manual.

! **The operating manual describes the maximum version of the controller, meaning that not all statements are relevant for your device.**

Description**Declaration of conformity**

This device corresponds to the requirements of the relevant guidelines and standards, if the corresponding regulations and the manufacturer's instructions are complied with.

Function

The device consists of a two-stage regulation for heat generators, a service water heating system, control system for two mixed heating circuits, as well as the following auxiliary functions:

- 1 timer-controlled output (circulation pump)
- 1 temperature-controlled output

The following functions may be assigned to this output (circulation pump, header pump, solar integration, heat generator for solid fuel, return flow temperature increase).

- Demand-related circulation pump control
- Automatic toggle between summer and winter time
- Automatic adjustment of function in accordance with the sensor configuration

Contents

General information	2
Safety information	2
Power connection regulations	2
Warranty conditions	2
Important text passages	2
Installation	2
Description	3
Declaration of conformity	3
Function	3
Contents	4
Part 1: Operation	8
Operation in normal mode	8
Operating elements	8
⊙ Operating mode selection	8
Effect of the operating mode	9
Display in normal operation	10
Changing the settings	11
Operating elements	11
Operating level	12
Areas	13
General	13
Display	13
Users	13
Time programs	13
Expert	13
Expert HS (only for HS via eBUS)	13

Levels	13
Installation	13
Hot water	13
Heat circuit I / II	13





Part 2: Overview of display values and settings 14

General area	14
Date/Time/Holiday	14
Service	16
Code number Entry	16
RELAY TEST	16
SENSOR TEST	17
SW NO XXX-XX	18
HS MANUAL (only with code no.)	18
BURNER TIME and BURN START	
(Not for HS via eBUS)	18
LIMITER TEST XX,X°C	18
SERVICE	19
RESET ...	19

Display Range	20
Installation	20
T-OUTSIDE	20
T-HS DES	20
T-HS	20
MOD DEPTH (only in the case of HS via eBUS connection)	20
Temperature of the multifunction relay	20
T-BUFFER B	21
Hot water	22

Heating circuit I / II	22	OPT HEAT UP (Heating optimisation)	28
T-DHW B (storage tank lower temperature)	22	MAX-OPT-TIME (Maximum bring-forward)	28
T-ROOM DES A (current value for set room temperature)	22	OPT REDUCED (Reduction optimisation)	28
T-ROOM (room temperature)	22	PC-ENABLE	28
		RETURN	28
User Area	23	Timer Program Area	29
Installation	23	List of available time programs	29
GERMAN => Language	23	Selecting a timer program	29
CONTRAST	23	Timer/heating program adjustment	30
DISPLAY SEL	23		
SELECT PROG	23	Expert area	33
Hot water	24	Installation	33
1X DHW (1x Hot water)	24	CODE-NO	33
T-DHW 1-3 DES		BUS-ID HS (- - - -)	33
(Hot water temperature setting)	24	BUS ID1 / 2 (heating circuit number)	33
BOB-VALUE (Operation Without Burner)	24	BUS TERMIN	34
CIRCL-P-DHW (Circulation with hot water)	24	EBUS SUPPLY (supply for eBUS)	34
ANTILEGION (Hot water short time heating function)	24	AF SUPPLY (Outdoor sensor power supply)	34
Heating circuit I / II	25	TIME MASTER	34
MODE	25	RESET TIME (resetting time for I-Controller)	34
T-ROOM DES 1-3	25	MAX T-HS	
T-REDUCED	25	(Maximum heat generator temperature)	35
T-ABSENCE	25	MIN T-HS	
T-LIMIT DAY/T-LIMIT N (Day/Night)	26	(Minimal heat generator temperature)	35
HEATSLOPE	26	T-WARM UP (Warm-up relief)	35
ADAPTION (heat slope adaption)	27	MIN-DELIMI (minimum limit heat generator)	35
ROOM INFL (Room sensor influence)	27	HYSTERESIS (dynamic switching hysteresis)	36
T-ROOM ADJ (room sensor adaptation)	27	HYST TIME (Hysteresis time)	36

Operation with two-stage heat generators or with 2 heat generators	36	MIXER CLOSED	
BLOCK-TIME (blocking time 2. burner stage)	36	(Mixer dynamics when closing)	48
HYST BURNER 2 (hysteresis 2. burner stage)	36	MAX T-FLOW(maximum flow temperature)	48
SEQUENCE CHANGE(time for switching HS)	37	MIN T-FLOW(minimum flow temperature)	48
HS COOL-FCT (Cooling function for the heat generator)	37	T-FROST PROT (frost protection temperature)	48
T-HS COOL (Start temperature for cooling)	37	T-OUT DELAY (outside temperature delay)	49
Auxiliary relay functions	38	SLOPE OFFSET (heating slope distance)	49
FUNC RELAY 1 (function selection relay 1)	38	B-HEAT SINK (circuit enable)	49
T-MF1 (Switching temperature relay 1)	38		
HYST MF 1 (Hysteresis relay 1)	38	Part 3: General function description	50
FUNC RELAY 2 (function selection relay 2)	40	Heat circuit control	50
Screed program	42	Weather-dependent control	50
SCREED (activation of screed drying process)	42	Room sensor influence	50
Hot water	43	Hot water generation	50
DHW RELIEF(Charge pump lock)	43	Frost protection function	50
PARALLEL DHW (Pump parallel running)	43	eBUS burner controls	51
T-HS DHW (Heat generator superheating during hot water preparation)	44	EEPROM check	52
HYST DHW (Hot water charging hysteresis)	44	Circulation pump control	52
DHW FOLLOWUP (pump run-down time)	44	Switched according to heating requirement	52
THERM INPUT (storage tank with thermostat)	44	Delayed pump switch-off	52
WALL HUNG (for modulating HG)	44	Pump blocking protection	52
LOAD THROUGH	45	Mixer motor blocking protection	52
Heating circuit I / II	46		
HC FUNCTION (heating circuit function selection)	46		
PUMP MODE (pump operating mode)	47		
MIXER OPEN (mixer dynamics when opening)	48		

Part 4: Installation and Start-up	53	Commissioning	67
Installation	53	Commissioning procedure	67
Assembly / Dismantling	53	System bus	68
Connecting instructions	54	The heating system	68
Notes on connecting heat generators via the CAN BUS (also with CoCo, e.g. CAN/OT)	54	Bus ID	68
System diagram	55	Error messages	69
System diagram with HS via eBUS	56	Troubleshooting	70
Electrical connection	57	Technical data	71
Version 1	57		
Version 2	58		
Power terminal assignments	59		
Sensor terminal assignments	60		
Remote controls	62		
The operator module Merlin BM, BM 8, Lago FB	62		
Remote control FBR2	62		
Sensor resistances FBR	63		
DCF receiver	63		
PC	63		
Maximum delimiter	64		
Telephone switch	64		
Sensor values / characteristic curve	65		
Outdoor sensor AF (AFS) 	66		
Boiler sensor KF (KFS) 	66		
Flow sensor VF (VFAS) 	66		
Storage tank sensor SPF (SPFS) 	66		

Part 1: Operation

For initial start-up, please read the chapter "Installation and Start-up"

Operation in normal mode

(operating flap closed)



Operating elements

 Change the set operating mode

 Operating mode selection

Turn the knob to select the operating mode required. The operating mode selected is indicated by a symbol at the bottom of the display. It takes effect when the setting is not changed for 5 s.

The following operating modes are available for selection:

 **Standby / OFF**
(Heating OFF and hot water preparation OFF, only frost protection mode)

 **Automatic mode 1**
(Heating according to timer program 1; DHW according to DHW program)

 **Automatic mode 2**
(Heating according to timer program 2; DHW according to DHW program)

 **Day mode**
(24 h heating with comfort temperature 1; HW according to HW program)

 **Night mode**
(24 h heating with reduced temperature; HW according to program)

 **Summer mode**
(Heating OFF, HW according to HW program)

 **Service** (automatic reset after 15 min)
heat generator regulated to heat generator set temperature
= max. heat generator temperature= see page 35 ; when
the heat generator temperature has reached 65°C, the
consumers are regulated to their flow temperature to dissi-
pate heat (cooling function).

! The cooling function must be explicitly enabled in
the consumer circuits by means of the parameter
B-HEAT SINK.

Effect of the operating mode

The operating mode set here affects the HS regulation and
the integrated heating circuits of the controller.

Each heating circuit can be assigned a separate operating
mode from the one set by means of the "operating mode"
parameter in the user level of the corresponding heating
circuit.

If the "☺ = Standby/OFF", and "☀ = Summer mode" oper-
ating modes are set at the boiler controller, these settings
have a reducing effect on all heating circuits / consumer
circuits that are present in the entire system.

! For mixing controller only on these heating circuits.

Display in normal operation

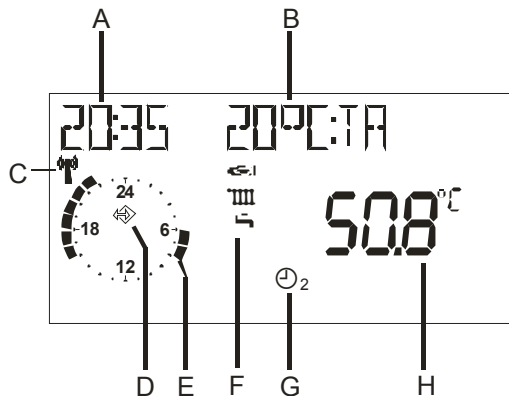

! Due to the tolerances of sensors, deviations of +/- 2K (2°C) are normal between various temperature displays. Temperatures which change rapidly can have higher deviations for short periods due to the different time-related behaviour of various sensors.

! The display of the current heating program applies to the device's first heating circuit. In case of having two heating circuits the display can be set to the 2nd circuit

Explanations

- A Current time
- B Freely selectable display (refer to "DISPLAY SEL" parameter)
- C DCF reception OK (only if receiver is connected)
- D Bus symbol (check data lead to connected controllers if this symbol does not appear)
- E Display of the active heating program for the first heating circuit (here: 6:00 to 08:00 hrs and 16:00 to 22:00 hrs)
- F Status display: Burner ON; heating mode; hot water preparation
- G Mode selector switch, the display applies to all heating circuits for which a separate operating mode has been selected via the "MODE" set value (here: 2 => Heating according to timer program 2).
- H Display of current heat generator temperature

Changing the settings

The operating flap must be opened first in order to change or request set values.

=> Controller switches to Operation mode

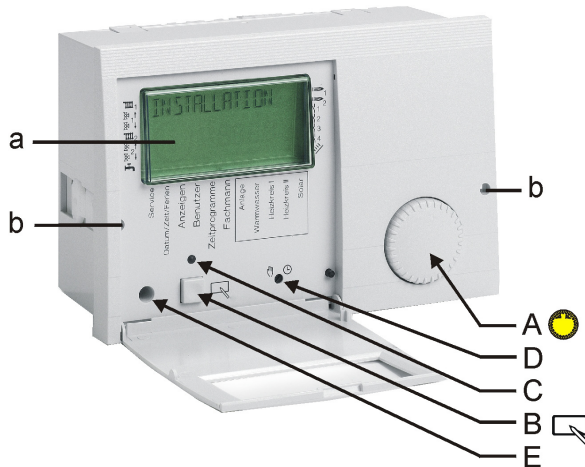

- a Display indicating the current level
- b Holes to unlock the controller fixation.
Insert a thin screwdriver deep into the holes and then lift up the controller.

Operating elements



A => Shaft encoder
Search for value/level or adjust value



B => Programming key

- Select a value level
- Select a value level to change
- Save a new value



C => Change display
LED ON => The value in the display can be changed by actuating the shaft encoder (A).



D => Manual-Automatic switch.
In Manual mode, all the pumps and first burner stage are switched on. The mixers are not adjusted / controlled (display: "EMERG-MODE").

Limitation (switch-of with 5K hysteresis):

- Burner => MAX T-HS (Expert)
- Heating pumps => MAX T-FLOW (expert)
- Cylinder charging pump => T-DHW I (user)



Caution, overheating, e.g. with floor or wall heating! => Set mixer by hand!

E => PC connection via optical adapter

Operating level



	General	SERVICE DATE/TIME/HOLIDAY
Open operating flap	☹ Turn anticlockwise ↗	
	☹ Turn clockwise ↘	
Display		INSTALLATION
		HOT WATER
		HEAT CIRCUIT I
		HEAT CIRCUIT II
User		INSTALLATION
		HOT WATER
		HEAT CIRCUIT I
		HEAT CIRCUIT II
Time programs		CIRCL TIME
		HOTW-PROG
		HTG-PROG I  1
		etc...
Expert		INSTALLATION
		HOT WATER
		HEAT CIRCUIT I
		HEAT CIRCUIT II
Expert HS		INSTALLATION

Operation is divided into different areas:

General - Display - Users - Time Programs - Expert - Expert HS

Opening the hinged control panel cover automatically takes you to the display and indicator area.

- The current area "DISPLAY" appears in the display for a short time (1 clock circuit).
- After the clock circuit the display switches to the current operating level "INSTALLATION".
- This is displayed for a short time (1 clock circuit) when you switch to a new area.

- ☹ Select the level in which the value to be adjusted or displayed can be found using the rotary knob.
-  Press Prog button! => Open / select level
- ☹ Search for value using rotary knob
-  Press Prog button! => Select value LED lights up => adjustment can now be made
- ☹ Modify value using rotary knob
-  Press Prog button! => Store value - LED goes off

Areas

General

Value selection summary

Service => for service engineers

Date/Time/Holiday => for users

Display

System value display (e.g. sensor values and setpoints).
No adjustments can be made. Operating errors are therefore excluded in this area.

Users

Summary of settings that can be made by the operator.

Time programs

Summary of time programs for heating circuits, the hot water circuit and possibly the circulation pump

Expert

Summary of values for which expert knowledge is required to make settings (installation technician).

Expert HS (only for HS via eBUS)

For parameters, refer to description of HS
Summary of the values transmitted by the automatic burner control system.

⚠ Making incorrect settings in the expert level can cause damage to the system or the property that is being heated. => The values in the expert level are protected by a code number.

Levels

The settings in the different areas are sorted into operating levels

- INSTALLATION
- HOT WATER
- HEAT CIRCUIT I
- HEAT CIRCUIT II

Installation

All display values and settings that relate to the heat generator or the entire system and cannot be assigned to a consumer circuit.

Hot water

All display values and settings that affect central hot water preparation and circulation.

Heat circuit I / II

All display values and settings that relate to the associated consumer circuit.

When heat circuit II is being configured as a hot water circuit, for example, the settings for this distributed hot water circuit can be found in the "Heat circuit II" operating level.



An overview of all settings can be found on the following pages.



Part 2: Overview of display values and settings



General area



(Select main level using  and open with )

Date/Time/Holiday

This area contains a series of different values in order to provide rapid access.

(Select values/value group using  and open with )

Date/time => Value group (General -> Date/Time/Holiday level) All the values in this group are set in sequence => adjust using  => continue with 	
TIME (Minutes)	Current minutes blink and can be adjusted
TIME (Hours)	Current hours blink and can be adjusted (seconds are set to "00" when stored)
YEAR	Adjust current year
MONTH	Adjust current month
DAY	Adjust current day (date)

 Hinged cover OPEN → search for level to the left with , open with 

- ! If a heating system controller has been set to be the TIME MASTER (time setting for all controllers, see EXPERT/INSTALLATION) or a DCF (Radio time receiver) has been installed in the system, the time is blanked out on all the other controllers in the system.
- ! There may be a time difference of up to 2 minutes per month (correct time if necessary). If a DCF receiver is connected the correct time is always displayed.

The current weekday is calculated automatically. Checking can take place using the selectable additional display in the standard display => set to "Day"

It is possible to change from summer to winter time by entering the date.

Holiday => Value group (General -> Date/Time/Holiday level) All the values in this level are set in sequence => adjust using ☺ => continue with ↵	
YEAR START	Set current holiday start year
MONTH START	Set current holiday start month
DAY START	Set current holiday start day
YEAR STOP	Set current holiday end year
MONTH STOP	Set current holiday end month
DAY STOP	Set current holiday end day

Summer time => Value group (General -> Date/Time/Holiday level) All the values in this level are set in sequence => adjust using ☺ => continue with ↵	
MONTH START	Set month for start of summer time
DAY START	Set earliest day for start of summer time
MONTH STOP	Set month for start of winter time
DAY STOP	Set earliest day for start of winter time

- ! Please do not enter the day of travel as the start date, but the first day of the holiday (no more heating from this day).
- ! Please do not enter the day of travel as the end date, but the last day on which there is to be no heating. When you arrive home the house should be warm and there should be hot water.
- ! Stop holiday function => e.g. for early return by pressing the program switch.
- ! Not with Time Master or DCF
- ! The default setting is valid for Central European time zones. A modification is only required if the date for the time change is changed by political decree.
- ! The earliest date on which the change will occur must be set. The controller performs the time change on the Sunday following this date at 2.00 am or 3.00 am.
- ! If no time change is required, please set MONTH STOP to the same value as MONTH START and DAY STOP to the same value as DAY START.

Service

This area contains values for the customer service engineers in order to provide rapid access.

(Select operating level using and open with)

Relay test => Value group (code no. required) (General -> Service level) Select relay using => relay switches	
00	No relay
01	Pump, heating circuit 1
02	Mixer OPEN, heating circuit 1
03	Mixer CLOSED, heating circuit 1
04	Pump, heating circuit 2
05	Mixer OPEN, heating circuit 2
06	Mixer CLOSED, heating circuit 2
07	Burner 1 ON
08	Burner 1 and 2 ON (2 after 10 seconds)
09	Hot water charging pump
10	Timer-controlled relay (multifunction relay 2)
11	Temperature-controlled relay (multifunction relay 1)

Hinged cover OPEN → search for level to the left with , open with

A code number must be entered for this function.

Select Relay Test => "Code number" level

Code number Entry

Start code number entry => [LED]

Select 1st digit

Confirm entry

Select 2nd digit

Confirm entry

Select 3rd digit

Confirm entry

Select 4th digit

Confirm entry

=> "Relay Test"

RELAY TEST









Start relay test

Select relay => Relay switches

Select next relay or use

to stop relay test

Start sensor test with , use to select sensor => temperature is displayed; Use to stop sensor test

Sensor test => Value group (General -> Service level) Select sensor using ☺ => value is displayed	
T-OUTSIDE	Outside temperature
T-HS	Temperature of the heat generator
T-DHW	Hot water temperature
T-FLOW  1	Flow temperature, heating circuit 1
T-ROOM  1	Room temperature heating circuit 1 (only with remote control)
T-DHW F  1	Storage tank charging via heat exchanger, flow temperature HC1
T-DHW B  1	Hot water storage tank temperature, lower heating circuit 1
T-FLOW  2	Flow temperature, heating circuit 2
T-ROOM  2	Room temperature heating circuit 2 (only with remote control)
T-POOL  2	Swimming pool temperature, heating circuit 2
T-DHW B  2	Hot water storage tank temperature, lower heating circuit 2
T-RETURN T-SOLID FUEL, T-HEADER T-SOL PANEL T-CIRCL T-DHW B T-MF1	Temperature of the multifunction sensor => Display according to function set for multifunc- tion relay (see left)
T-BUFFER B	For solid fuel or solar integration => Sensor in storage tank

SENSOR TESTMultifunction sensor according to function set for relay

01 = Header pump

=> T-HEADER = Collector temperature (display only if sensor is connected)

20 = Temperature-controlled circulation pump

=> T-CIRCL = Temperature of circulation pipe return

21 = Circulation pump via pulse

=> no temperature display (display with ON/OFF)

Parameter LOAD THROUGH at the level Expert –Hot water is activated (=01)

=> T-DHW B = Temperature of the hot water tank at the inlet area

22 = Integration of the heat generator for solid fuel

=> T-SOLID FUEL = Temperature of the heat generator for solid fuel,

=> T-BUFFER B = Temperature of the storage tank at the inlet area

23 = Solar integration

=> T-SOL PANEL = Temperature of the solar collector,

=> T-BUFFER B = Temperature of the storage tank in the inlet area

24 = Return flow temperature increase

=> RETURN TEMP = Return temperature to HS

32 = Heating circuit direct => HTG CIRCUIT3 (display ON/OFF)

T-MF1=> Temperature display without function selection
=> without sensor no display (- - -)

Other entries (General -> Service level) Select value using ☺ => value is displayed	
SW NO XXX-XX	Software number with index
HS MANUAL	Only for HS via eBUS
BURNER TIME 1 ➡	🔍 burn time (h) burner 1
BURNER START 1 ➡	🔍 Burner starts for burner 1
BURNER TIME 2 ➡	🔍 burn time (h) burner 2
BURNER START 2 ➡	🔍 Burner starts for burner 2
LIMITER TEST XX,X°C	Safety temperature limiter test with heat generator temperature display Start with 🔍 (hold down)!
SERVICE (only with code no.)	Input of date / operating hours for the yearly maintenance message
RESET USER 00	Load factory settings for user parameters. (Except language)
RESET EXPERT 00 (only with code no.)	Load factory settings for Expert parameters. (Except sensors)
RESET T-PRG 00	Load time program factory settings
RETURN	Exit level using 🔍

SW NO XXX-XX

Display software number with index (please specify if you experience problems or have questions about the controller)

HS MANUAL (only with code no.)

Only for HS via eBUS

Open level with 🔍 and select burner stage using ☺.

After the heat generator 🔍 has been selected, the output for this heat generator can be set.

With respect to multi-stage heat generators, the second stage can be activated by presetting an output value > 50%.

After closing the service functions the entries are reset automatically.

BURNER TIME and BURN START (Not for HS via eBUS)

🔍 => Display of current value 🔍 => Return
🔍 hold down until "RESET" display goes off => Reset display

LIMITER TEST XX,X°C



Display of heat generator temperature.

🔍 Hold down prog. button until LIMITER activates
=> Burner I ON; all pumps OFF; all mixers CLOSE
The temperature can be observed in the display.

SERVICE

Input of values for the yearly maintenance message

Delete active maintenance display:

Open control panel cover, press prog. button 2x , set display value to "00" using  and confirm with .

Delete programmed yearly message:



At the level General/Service set the value SERVICE

=>DAY or



SERVICE => OPERATING H to dashes.

RESET ...



The three value groups can be reset to the factory setting using the Reset function.

Select function using , set to "01" using  and confirm with .

Display Range

 Hinged cover OPEN → search for level to the right with , open with 

! Display only. No adjustments possible.

Installation	
(HG => heat generator)	
Select parameter using  => value is displayed	
T-OUTSIDE	Outside temperature
T-HS DES	HG temperature setting
T-HS	HG flow temperature
MOD DEPTH	Modulation degree of HS (BUS)
T-RETURN	HS return temperature
T-SOLID FUEL	Temperature of the heat generator for solid fuel
T-HEADER	Header temperature
T-SOL PANEL	Temperature of the solar collector
T-CIRCL	Return flow temp. of the circulation
CIRCL IMPULS	Circulation via pulse
T-DHW B	Temp. of the hot water tank lower measuring point (see hot water functions)
HTG CIRCUIT3	Additional direct heating circuit
T-BUFFER B	Buffer storage lower temperature
RETURN	Exit level using 

! Display only appears if the sensor is connected and the value is present in the system. If the set value is not present it is masked out, or hyphens appear in the display (- - -).

T-OUTSIDE

The measured outside temperature is smoothed for control purposes. The smoothed value is displayed here.

T-HS DES

Corresponds to the maximum required temperature of the consumer circuits from the heating system (incl. hot water preparation). The mixer circuits request the temperature + heating curve distance (expert value)

T-HS

Measured actual temperature of the heat generator

MOD DEPTH (only in the case of HS via eBUS connection)

Only if a modulating heat generator is connected via eBUS and transmits this value.

Temperature of the multifunction relay

T-RETURN = Return temperature of system

T-SOLID FUEL = Temperature of the heat generator for solid fuel, => T-BUFFER B = Temperature of the storage tank at the inlet area

T-HEADER = Collector temperature
(display only if sensor is connected)

T-SOL PANEL = Temperature of the solar collector,
=> T-BUFFER B = Temperature of the storage tank at
the inlet area

T-CIRCL = Return temperature of the circulation pipe

CIRCL PULSE = for circulation pump via pulse the pulse
input status is displayed
(ON/OFF)

T-DHW B = Temperature of hot water storage tank at inlet
area

HTG CIRCUIT3 = for additional direct heating circuit the
pulse input status is displayed (ON/OFF)

T-BUFFER B

For solid fuel or solar integration => Buffer storage tank
temperature at the inlet area

Hot water	
T-DHW DES	Current hot water set temperature according to heating program and operating mode
T-DHW	Current hot water temperature
T-DHW B	Current temperature of HW tank in the lower section (charge-through)
RETURN	Exit level using 

Heating circuit I / II	
T-ROOM DES A	Current room set temperature according to heating program and operating mode
T-ROOM	Current room temperature
T-POOL DES *)	Swimming pool temperature setting
T-POOL *)	Current swimming pool temperature
HUMIDITY ***)	Current relative humidity
T-DHW DES **)	Hot water temperature setting
T-DHW **)	Current hot water temperature
T-FLOW DES	Current flow temperature setting
T-DHW B **)	Lower hot water storage tank temp.
T-DHW F **)	Storage tank charging via heat exch.
T-FLOW	Current flow temperature
N-OPTI-TIME	Previous time required to heat up with heat-up optimisation activated
RETURN	Exit level using 

! Display only appears if the sensor is connected and the value is present in the system. If the set value is not present it is masked out, or hyphens appear in the display (- - -).

T-DHW B (storage tank lower temperature)

Temperature at lower hot water tank sensor. The value is only displayed if the value "LOAD THROUGH" is activated at the level EXPERT => HOT WATER.

T-ROOM DES A (current value for set room temperature)

If an operator device is connected, there is no display ("- - -") in the controller => Value is displayed in the operator device

T-ROOM (room temperature)

Only if a sensor or an FBR is connected.





*) These values only appear if the heating circuit is programmed for regulating a pool.

) These values only appear if the heating circuit is programmed as a hot water circuit.

***) This value is only displayed if an operator device is connected and the parameters have been set for the corresponding heating circuit.
 "- - -", => no humidity sensor available in operator device



User Area

All the settings that can be made by the operator of the system.

Installation			
All settings that <u>cannot</u> be assigned to a consumer circuit (consumer circuits: heating circuits and HW).  Select value,  adjust and  save			
Designation	Value range	Default	IV*)
GERMAN	Acc. to version	GERMAN	
CONTRAST	(-20) – (20)	0	
DISPLAY SEL	Sensor, weekday	----	
SELECT PROG	Heat circuit 1, HC 2	1	
RETURN	Exit level using 		

*) **IV** = Internal Values:

Space for entering the parameters stored in the system!

 Hinged cover OPEN → search for level to the right with ,
open with 

GERMAN => Language





Select controller language

CONTRAST

Adjust intensity of display

DISPLAY SEL

Select additional display in standard operation

---- => no additional display of
 DAY => Week day (Mon, Tue, Wed,)
 T-OUTSIDE => Outside temperature
 T-FLOW  1 => Flow temperature heating circuit 1
 T-FLOW  2 => Flow temperature heating circuit 2
 T-DHW => Hot water temperature (upper)
 T-HS => Heat generator temperature
 T-ROOM  1 => Room temperature heating circuit 1 => *)
 T-ROOM  2 => Room temperature heating circuit 2 => *)

*) only if remote control is connected

SELECT PROG

Select heating circuit whose heating program is shown in the standard display.

Hot water			
Designation	Value range	Default	IV
1X DHW	00, 01 (OFF/ON)	00 = OFF	
T-DHW 1 DES	10°C - 70°C	60°C	
T-DHW 2 DES	10°C - 70°C	60°C	
T-DHW 3 DES	10°C - 70°C	60°C	
BOB-VALUE	0K – 70K	0 K	
CIRCL-P-DHW	00, 01 (OFF/ON)	00 = OFF	
ANTILEGION	00, 01 (OFF/ON)	00 = OFF	
RETURN	Exit level using 		



Hot water short time heating function

ANTILEGION = 01 => Every 20th time that heating takes place or once per week on Saturday at 01:00 hrs the storage tank is heated up to 65°C.

It is possible to set up your own hot water short time heating function using the third hot water enable facility.

1X DHW (1x Hot water)

01 => The storage tank is enabled for charging once (e.g. for showering outside hot water times).

 Hinged cover OPEN → search for level to the right with , open with 

Charging starts when the temperature drops below set temperature " T-DHW 1 DES " by the switching hysteresis. After charging, the value is automatically set to "00".

T-DHW 1-3 DES (Hot water temperature setting)

Required hot water temperature setting
 T-DHW 1 DES => used in first enable time,
 T-DHW 2 DES => used in second enable time ,
 T-DHW 3 DES => used in third enable time of hot water program.

BOB-VALUE (Operation Without Burner)

Energy saving function for solar or solid fuel integration. For settings > "0" the burner is not activated for hot water preparation until the hot water temperature has dropped below the temperature setting by the set value + the hysteresis.







! This function may be affected by alternative energy sources that are connected via bus (e.g. SD3-Can).



CIRCL-P-DHW (Circulation with hot water)

01 => The circulation pump runs when the hot water is enabled, but the circulation program is disabled.

ANTILEGION (Hot water short time heating function)

01 => Activation of hot water short time heating function



Heating circuit I / II			
Designation	Value range	Default	IV
MODE	---- ,  ,  ,  ,  , 	----	
T-ROOM DES 1*)	5°C - 40°C	20°C	
T-ROOM DES 2*)	5°C - 40°C	20°C	
T-ROOM DES 3*)	5°C - 40°C	20°C	
T-REDUCED *)	5°C - 40°C	10°C	
T-ABSENCE	5°C - 40°C	15°C	
T-LIMIT DAY	----, (-5)°C–40°C	19°C	
T-LIMIT N	----, (-5)°C–40°C	10°C	
HEATSLOPE	0,00 – 3,00	1,20	
ADAPTION	00, 01 (OFF/ON)	00 = OFF	
ROOM INFL	----, 00 – 20	10	
T-ROOM ADJ	(-5.0)K – (5.0)K	0,0 K	
OPT HEAT UP	00, 01, 02	00	
MAX OPT-TIME	0:00 – 3:00 [h]	2:00 [h]	
OPT REDUCED	0:00 – 2:00 [h]	0:00 [h]	
PC-ENABLE	0000 - 9999	0000	
RETURN	Exit level using 		

 Hinged cover OPEN → search for level to the right with ,
open with 

*) depending on function selector Heating circuit T-POOL, T-DHW, T-FLOW DAY or T-FLOW REDUC (see page 46)

MODE

---- => The controller programming switch applies in this case.

When setting an operating mode the mode only applies to the assigned heating circuit. When the " = Standby/OFF", and " = Summer mode" controller programming switch operating modes are set, this has a reducing effect on all heating circuits and consumer circuits in the entire system.

T-ROOM DES 1-3

Required room temperature setting
T-ROOM DES 1 => used in first enable time,
T-ROOM DES 2 => used in second enable time,
T-ROOM DES 3 => used in third enable time of active heating program for this heating circuit.

T-REDUCED

Required room temperature setting during night reduction

T-ABSENCE

Required room temperature setting during holidays

T-LIMIT DAY/T-LIMIT N (Day/Night)

Only valid if the function is activated => Set value "Expert/Heating circuit/PUMP MODE= 01=> Pump switching according to heating limit"

If the outside temperature that is measured and calculated by the controller exceeds the heating limit specified here, heating is disabled, the pumps switch off and the mixers are closed. The heating is enabled again when the outside temperature drops below the set heating limit by 1K (= 1°C).

T-LIMIT DAY => applies during heating times

T-LIMIT N => applies during reduction times

"----" => The heating limit is deactivated. The circulation pump is switched in accordance with the standard function (see chapter entitled "Circulation pump control")

HEATSLOPE

The gradient of the heat slope indicates by how many degrees the flow temperature changes if the outside temperature rises or drops by 1 K.

Setting tip:

At cold outside temperatures, room temperature too low => Increase heat slope (and vice-versa)

At high outside temperature (e.g. 16°C) room temperature too low => correction via set room temperature

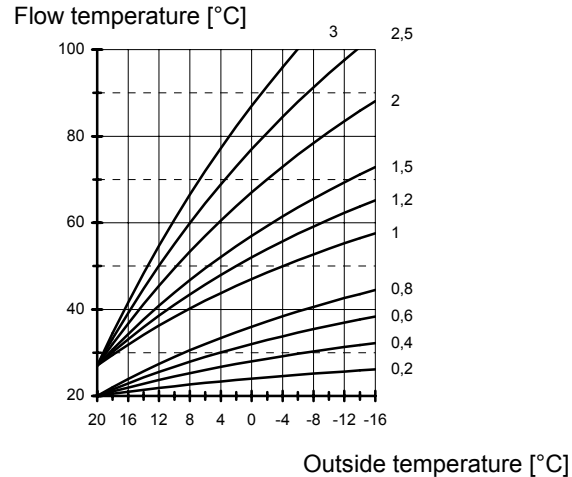

Heat slope diagram (setting aid)

Setting 0 => Room control only

! The heat slope can best be set at outside temperatures below 5°C. The change in heat slope setting must be made in small steps and at long intervals (min. 5 to 6 hours) because the system must first adjust to the new values each time the heat slope is changed.

Guideline values

- Underfloor heating S = 0.4 to 0.6
- Radiator heating S = 1.0 to 1.5

ADAPTION (heat slope adaption)

Only active if an FBR analogue room device is connected (room sensor + operating mode selection) and an outdoor sensor.

Function for automatic heat slope setting

Starting Conditions:

- External temperature < 8°C
- Operating mode is automatic (I or II)
- Duration of lowering phase at least 6 hours

At the beginning of the lowering period, the current room temperature is measured. During the next four hours, this temperature is used as the set point for the room regulator. The heating curve is calculated from the values determined during this time by the regulator for the flow pipe nominal temperature and the external temperature.

! If the adaption is interrupted, e.g. by a start-up discharge or the hot water demand from an external heating circuit, then the warning triangle will appear in the display until the function is carried out successfully the next day or is ended, e.g. by adjusting the operating mode switch.

! During the adaptation, the water heating and the heating optimisation of the regulator are blocked.

ROOM INFL (Room sensor influence)

Only active if an FBR analogue room device is connected (room sensor + operating mode selection).

The heat generator temperature is increased by the set value when the temperature drops below the required room temperature by 1K.

=> High values lead to fast control and large heat generator temperature fluctuations.

- - - - => pure weather-dependent control
- 0 => pure weather-dependent control *)
- 20 => pure room temperature control

*) Special function with ROOM INFL = 0

For one-off heating requirements during the night reduction the heating pump continues to run until the next heating period is reached (see chapter entitled "Circulation pump control").

T-ROOM ADJ (room sensor adaptation)

For room control (e.g. with FBR), the measurement can be corrected by means of this setting should the room sensor not measure correctly.

OPT HEAT UP (Heating optimisation)

Activation of function for automatically bringing forward the start of heating.

Example: Heating program 6.00 hrs – 22.30 hrs

OFF: Building starts to be heated at 6.00 hrs.

ON: Depending on weather and room temperature, heating starts soon enough so that building just reaches the set room temperature at 6.00 hrs.

00 => start of heating not brought forward

01 => brought forward depending on weather

02 => brought forward depending on room temperature *)

*) Only active if an FBR analogue room device is connected (room sensor + operating mode selection).

! Warm-up optimisation occurs only if the reduced time of the heating circuit is at least 6 hours.

MAX-OPT-TIME (Maximum bring-forward)

Only active with " OPT HEAT UP = 01 or 02"

The start of heating is brought forward by no more than this time.

OPT REDUCED (Reduction optimisation)

Automatic reduction of burner disabling to end of set heating time.

The burner is not restarted before the end of the heating period during the set time period (last heating time only) if it not already in operation.

This function prevents short-term heating of the heat generator to the end of the heating period.

PC-ENABLE

Code number for enabling access to heating circuit data from a PC



"0000" => access is blocked.

RETURN

Exit heating circuit level => Return to "User" area.





Timer Program Area

All the time programs can be set in this area.

 Hinged cover OPEN → search for level to the right with ,
open with 

Selecting a timer program



Open hinged cover => "Display => Installation",





-  to the right until clock
=> "USER => INSTALLATION",
-  to the right until clock => "TIME PROGRAM
=> CIRCL TIME"
-  Select timer program
=> e.g. "HTG-PROG 2  1"
= Heating program 2 for controller heating circuit 1
-  Confirm/open timer program
=> "MONDAY"

When connecting a digital room controller with heating program input, the corresponding heating program in this controller is automatically faded out.

List of available time programs

With maximum controller configuration

Select timer program using   select timer program for display or adjustment

CIRCL TIME	Switching program for circulation pump
HOTW-PROG	Enabling program for hot water charging pump
HTG-PROG 1  1	1. heating program for first controller heating circuit
HTG-PROG 2  1	2nd heating program for first controller heating circuit
HTG-PROG 1  2	1. heating program for second controller heating circuit
HTG-PROG 2  2	2nd heating program for second controller heating circuit
RETURN	Exit level using 

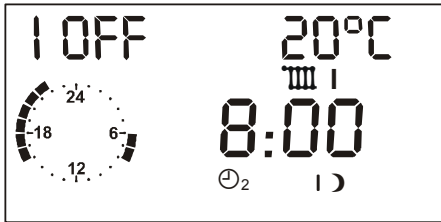
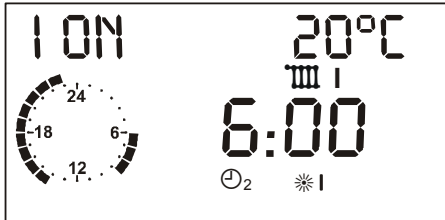

Symbols:

I ON = First switch-on time (I OFF = first switch-off time)

20 °C = Set room temperature for displayed heating time

Clock = Approximate program display [full hours]

III 1 = Program for heating circuit 1

⌚₂ = Heating program 2, ⌚₁ = Heating program 1

*I = Start time 1, I) = Stop time 1, *II = Start time 2,
II) = Stop time 2, *III = Start time 3, III) = Stop time 3

Timer/heating program adjustment

⌚ Select weekday (Mo-Su) or block
(MO-FR => Monday-Friday, SA-SU => Saturday-Sunday,
MO-SU => Monday-Sunday)

🗒️ Open weekday/block (see left)

=> "I ON 20°C" First switch-on time – set value I = 20°C

⌚ Set first switch-on time => for example 6:00 hrs

🗒️ Confirm first switch-on time

=> „I OFF 20°C" First switch-off time – set value I = 20°C

⌚ Set first switch-off time => for example 8:00 hrs

🗒️ Confirm first switch-off time

=> „II ON 20°C" Second switch-on time – set value II = 20°C

⌚ 🗒️ Switch-on and switch-off times 2 and 3 are entered in the same way - please enter all values!

⌚ Select another weekday/block for entry or exit heating program 2 with "RETURN" and set another program.

! The heating times are not saved until all the times for a weekday/block have been entered.

"- - - -" for a switch-on/switch-off time => The relevant heating timer is deactivated.

Heat circuit 1

Heating program 1 => factory setting:

Mo. to Fr.: 06:00 to 22:00

Sa. and Su.: 07:00 to 23:00

	Heating time 1	Heating time 2	Heating time 3
Mo.			
Tu.			
We.			
Th.			
Fr.			
Sa.			
Su.			

Heating program 2 => factory setting:

Mo. to Fr.: 06:00 to 08:00, 16:00 to 22:00

Sa. and So.: 07:00 to 23:00

	Heating time 1	Heating time 2	Heating time 3
Mo.			
Tu.			
We.			
Th.			
Fr.			
Sa.			
Su.			

Heat circuit 2

Heating program 1 => factory setting:

Mo. to Fr.: 06:00 to 22:00

Sa. and Su.: 07:00 to 23:00

	Heating time 1	Heating time 2	Heating time 3
Mo.			
Tu.			
We.			
Th.			
Fr.			
Sa.			
Su.			

Heating program 2 => factory setting:

Mo. to Fr.: 06:00 to 08:00, 16:00 to 22:00

Sa. and So.: 07:00 to 23:00

	Heating time 1	Heating time 2	Heating time 3
Mo.			
Tu.			
We.			
Th.			
Fr.			
Sa.			
Su.			

Hot water

Factory setting:

Mo. to Fr.: 05:00 to 21:00

Sa. and So.: 06:00 to 22:00

 Heating time 1	Heating time 2		Heating time 3	
Mo.				
Tu.				
We.				
Th.				
Fr.				
Sa.				
Su.				

Circulation

Factory setting:

Mo. to Fr.: 05:00 to 21:00

Sa. and So.: 06:00 to 22:00



 Heating time 1	Heating time 2		Heating time 3	
Mo.				
Tu.				
We.				
Th.				
Fr.				
Sa.				
Su.				

Expert area

These settings can only be changed if the code no. is entered (see page 16).

⚠ If these values are set incorrectly, they may cause malfunctions or damage to the system.

Installation			
Designation	Value range	Default	IV
CODE-NO	0000 - 9999	Entry	
CODE-NO (Adjustment)	0000 - 9999	0000	
BUS-ID HS	----, 01 - 08	----	
BUS ID 1	(- - - - ,00), 01-15	01	
BUS ID 2	(- - - -), 02-15	02	
BUS TERMIN	00, 01 (OFF/ON)	01 00 (1124)	
EBUS SUPPLY	00,01 (OFF / ON)	01 = ON	
AF SUPPLY	00,01	01 = ON	
TIME MASTER	00, 01	00 = OFF	
DYN UPWARD *)	20 – 500 K	100 K	
DYN DOWNWARD *)	20 – 500 K	100 K	
RESET TIME *)	5 - 500	50	
MAX T-HS	30°C - 110°C	85°C	
MIN T-HS	10°C - 80°C	40°C 1)	
T-WARM UP	10°C - 85°C	35°C 2)	
MIN-DELIMI	00, 01, 02	00 3)	
See following pages for continuation			











 Hinged cover OPEN → search for level on right with ,
open with 

*) only for HS via eBUS

- 1) Controller .0324-P and .0634-P = 67°C
- 2) Controller .0324-P and .0634-P = 62°C
- 3) Controller .0324-P and .0634-P = 01

CODE-NO

Entering the code number (see page 16) allows all of the expert settings to be modified => including the code number itself (first parameter)

( on right => CODE-NO 0000  =>  1st digit  =>  2nd digit  =>  3rd digit  =>  4th digit  => 

BUS-ID HS (- - - -)

(not an option in all models)

The controller will be used as cascade with setting "01-08".
The heating circuits are then not available anymore.

BUS ID1 / 2 (heating circuit number)

The heating circuits are sequentially numbered starting with "01". heating circuit numbers must not be assigned twice. For replacement controllers, please enter exactly the same heating circuit numbers as the replaced controller.

BUS TERMIN

This parameter is used to switch the terminal resistance for Can communication. The entire system may contain exactly one terminating resistor.

Delivery state:

- Mixer controller (1124) => "00"
- Boiler controller (0634, 0324,...) => "01".

(Parameter BUS ID HS1 > 00 => BUS TERMIN = 00)

△ When loading the factory settings, the terminal resistance is newly set (according to boiler sensor).

EBUS SUPPLY (supply for eBUS)

Switching the eBUS supply on / off in relation to connected devices (power supply balance) => see part 3:
Description of functions – eBUS burner controls.

AF SUPPLY (Outdoor sensor power supply)

Switching off the power supply to the outdoor sensor. Switching off allows up to 5 controllers to be operated with a single outdoor sensor. The power supply must only be switched on if there is one controller per sensor = "01".

TIME MASTER

(Only without or TIME MASTER in system)

00 no time master => each heating circuit has its own time
01 controller is time master => all controllers and remote controls take over the time settings of this controller.

! No more than 1 TIME MASTER is permitted in the system!

DYN UPWARD (dyn. heat generator connection [K])

Small value = fast connection

Large value = slow connection

△ Values set too low can lead to overheating or short-term connection of a heat generator.

Calculation: If the cumulative system deviation in Kelvin reaches the set value A, this results in connection of all heat generator stages.

DYN DOWNWARD (dynamic heat generator deactivation [K])

Small value = fast deactivation

Large value = slow deactivation

△ Values set to high can lead to overheating and triggering the STB

Calculation: If the cumulative system deviation in Kelvin reaches the set value A, this results in deactivation of all heat generators.

RESET TIME (resetting time for I-Controller)

△ Control value: Changing this value can cause the control system to overshoot. The recommended default settings should be retained.

! Small values cause the mixer motor to adjust quickly and can lead to oscillation.

MAX T-HS (Maximum heat generator temperature)

- Protects the heat generator from overheating / prevents triggering the LIMITER.
- Limiting the heat generator temperature to save energy.

! Caution: Also works with hot water preparation.

MIN T-HS (Minimal heat generator temperature)

Reduces condensation in the heat generator when heating demand is low. In all cases, the heat generator is never switched off before the minimal heat generator temperature has been reached

MIN T-HS + HYSTERESIS (also see MIN-DELIMI).

T-WARM UP (Warm-up relief)

Reduces operation in condensation zone. The circulation pumps are switched off and the mixers are shut until the heat generator has reached the start-up temperature.

MIN-DELIMI (minimum limit heat generator)

Reduces condensation in the heat generator when heating demand is low. In all cases, the heat generator is never switched off before the minimal heat generator temperature has been reached MIN T-HS + HYSTERESIS.

00 = Minimum limit on heat slope

The heat generator switches on when the temperature drops below the temperature demanded by the consumers (T-HS DES).

01 = Minimum limit during heating requirement During heating requirement (Pump enabled), the heat generator maintains at least the set minimum temperature MIN T-HS.

02 = Permanent minimum limit (24 hours)

The heat generator maintains at least the set minimum temperature MIN T-HS over 24 hours.

Installation			
Designation	Value range	Default	IV
HYSTERESIS	5K – 20K	5 K	
HYST TIME	00min – 30min	00 min	
BLOCK-TIME	00min – 30min	00 min	
HYST BURNER 2	2K – 20K	2 K	
BOILER SEQ	0h – 250h	0h	
Cooling function			
HS COOL-FCT	00 – 01	00	
T-HS COOL	30°C - 120°C	95°C	
See following pages for continuation			

HYSTERESIS (dynamic switching hysteresis)

HYST TIME (Hysteresis time)

Function for optimising heat generator operation with differing heat generator loads.

The effective switching hysteresis is reduced linearly after the burner is switched on from the set HYSTERESIS to the minimum hysteresis (5K) during the hysteresis time "HYST TIME".

Low heat consumption

If the system consumes little heat, the heat generator quickly reaches the set temperature. In this case the

higher HYSTERESIS setting takes effect. Short run-times and frequent burner operation are prevented.

High heat consumption

During longer periods of burner operation (high heating load) the hysteresis is automatically reduced to 5K. This prevents the heat generator from heating to unnecessary high temperatures. The energy consumption of the heating system is optimised.

! The set value of "00" produces a constant hysteresis value.

Operation with two-stage heat generators or with 2 heat generators

BLOCK-TIME (blocking time 2. burner stage)

! 00 = 10 sec.; Please consider the internal block times of the connected burner controllers to make the correct settings.

HYST BURNER 2 (hysteresis 2. burner stage)

Switch on the 1st Burner stage when temperature drops below set temperature of the heat generator.

Switch off the 1st burner stage when the temperature setting is exceeded by the HYSTERESIS.

Switch on the 2nd burner stage

- after start of 1st burner stage

- and temperature drops below temperature setting by 5K (= start of blocking time / enable 2nd. burner stage)
- and expiration of blocking time

Switch off 2nd burner stage when the temperature setting is exceeded by the HYSTERESIS.

Switch 2nd Burner stage when temperature drops below set temperature of the heat generator.

Switch off the 1st burner stage when 2nd stage enabled after set temperatures are exceeded by [HYSTERESIS + HYST BURNER2]

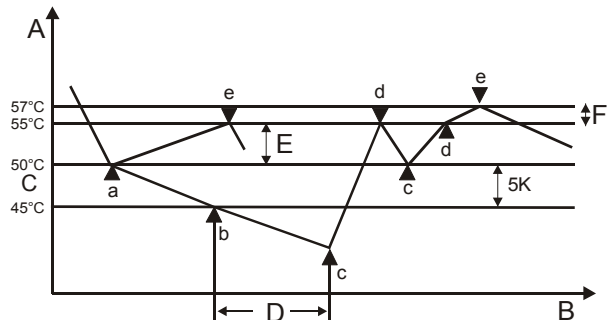

- A Temperature of the heat generator
- B Time
- C Set temperature of the heat generator
- D BLOCK-TIME (blocking time 2. burner stage)
- E HYSTERESIS (dynamic switching hysteresis)
- F HYST BURNER2 (hysteresis for 2nd heat generator)

- a Stage 1 on
- b Start of blocking time
- c Stage 2 on (stage 2 enable)
- d Stage 2 off
- e Stage 1 off (cancel stage 2 enable)

SEQUENCE CHANGE(time for switching HS)

Only for operation with two heat generators.

The controller can be optionally used for controlling heating systems with two-stage burners or heating systems with two single-stage heat generators. For operation with two heat generators, there is the option to switch the HS sequence after the number of operating hours set here for the current heat generator "1".

HS COOL-FCT (Cooling function for the heat generator)

T-HS COOL (Start temperature for cooling)

△ Applies to 1st heat generator or the solid fuel boiler (multifunction relay 1)!

If the cooling function for the heat generator is activated (HS COOL-FCT = 01), the heating circuits are put into operation with T-FLOW MAX (if cooling function permitted in HC) as soon as the set starting temperature T-HS COOL is exceeded by one of the heat generators. The cooling function is stopped when the temperature drops below the start temperature T-HS COOL by 5K.

Installation			
Designation	Value range	Default	IV
FUNC RELAY 1	00 - 32	01	
T-MF1	30°C - 90°C	30°C	
HYST MF 1	2K – 10K	5 K	
FUNC RELAY 2	00 - 06	02	
See following pages for continuation			

Auxiliary relay functions

The sensor \uparrow 1 (connector VIII, pin 1+2) is assigned to the relay \uparrow 1 (temperature-controlled) (also see page 17). If a further sensor is required for a function, this sensor must be connected to connector III, pin 2+3.

Functions which do not require a sensor are assigned to relay \uparrow 2 (timer-controlled).

FUNC RELAY 1 (function selection relay 1)

! If the parameter "LOAD THROUGH" is activated at the level EXPERT=>HOT WATER, the additional functions with sensor integration are not possible (function 20 – 32)

T-MF1 (Switching temperature relay 1)

HYST MF 1 (Hysteresis relay 1)

00 = no function

01 = Header pump

ON: When heat is requested by a consumer

OFF: Without consumer heat request

If at least one consumer in the system requests heat the pump is switched on. The after-run function is effective after the heat generator is switched on.

02 = Circulation (time)

The circulation pump is switched on according to the circulation or hot water program (parameter "CIRCL-P-DHW" at the level USER=>HOT WATER).

03 = Booster pump

ON: In the event of a heating request from an internal consumer

OFF: Without internal consumer heating request A pump after-run occurs.

05 = Pump heat generator 1

When using the controller to control two heat generators the relay may be used to control the heat generator pump for heat generator 1.

(Relay switches with burner relay 1; run-down =5 min)

06 = HS pump heat generator 2

When using the controller to control two heat generators the relay may be used to control the heat generator pump for heat generator 2.

(Relay switches with burner relay 2; run-down =5 min)

20 = Temperature-controlled circulation pump

T-CIRCL = Return flow temperature of circulation line

ON: $T-CIRCL < T-MF1$

OFF: $T-CIRCL > [T-MF1 + HYST MF 1]$

The circulation pump is switched on when the return flow temperature drops below the set limit temperature (T-MF1). The pump is switched off again when the return flow temperature exceeds the set limit temperature by the Hysteresis (HYST MF 1).

The set circulation program and the "Circulation with hot water" setting have an overriding function

=> Switching on only takes place during enable periods.

21 = Pulsed circulation pump

ON: In the event of short circuit at multifunction sensor input

OFF: After 5 minutes

If a short-cut occurs at the multifunction sensor input the circulation pump is switched on for 5 minutes. Switching on takes place on the edge (once only).

The set circulation program and the "Circulation with hot water" setting have an overriding function

=> Switching on only takes place during enable periods.

22 = Integration of the heat generator for solid fuel

T-SOLID FUEL = Temperature of the heat generator for solid fuel

T-BUFFER B = Temperature of the storage tank at the inlet area (connector III, pin 2+3)

ON: $T-SOLID FUEL >$

$[T-BUFFER B + HYST MF 1 + 5K]$

OFF: $T-SOLID FUEL <$

$[T-BUFFER B + HYST MF 1]$

Start-up relief:

ON: $T-SOLID FUEL > T-MF1$

OFF: $T-SOLID FUEL < [T-MF1 - 5K]$

The pump is switched on when the temperature of the heat generator for solid fuel exceeds the temperature of the buffer storage at the inlet area (T-BUFFER B) by the hysteresis (HYST MF 1 + 5K). Switching off occurs when the temperature drops 5K below the switch-on temperature.

Switching off additionally occurs when the temperature of the heat generator for solid fuel drops below the set limit temperature

(T-MF1) by 5K. The pump is enabled again when the temperature of the heat generator for solid fuel exceeds the set limit temperature (T-MF1).

Disabling the HS1:

ON: $T-SOLID FUEL + 5K > T-HS DES$ and solid fuel boiler pump = ON

OFF: $T-SOLID FUEL < T-HS DES$ or solid fuel boiler pump = OFF

! Disabling the HS1 only occurs if the solid fuel boiler is integrated in the HS1 controller.
If the cooling function is activated, it will also affect the solid fuel boiler function.

23 = Solar integration

T-SOL PANEL = Temperature of the solar collector
T-BUFFER B = Temperature of the storage tank at the inlet area (connector III, pin 2+3)
ON: T-SOL PANEL >
[T-BUFFER B + HYST MF 1 + 5K]
OFF: T-SOL PANEL <
[T-BUFFER B + HYST MF 1]

The pump is switched on when the temperature of the solar collector exceeds the temperature of the buffer storage at the inlet area (T-BUFFER B) by the hysteresis (HYST MF 1 + 5K). Switching off occurs when the temperature drops 5K below the switch-on temperature.

Safety / system protection:

OFF: T-BUFFER B > T-MF1
ON: T-BUFFER B < [T-MF1 – 5K]

Switching-off occurs when the temperature of the storage tank at the inlet area exceeds the set limit temperature (T-MF1). The pump is enabled again when the storage tank temperature drops below the limit temperature by 5K.

24 = return flow temperature increase

T-RETURN = Return temperature of system
ON: RETURN TEMP < T-MF1
OFF: RETURN TEMP > [T-MF1 + HYST MF 1]

The return flow temperature increase pump is switched on if the return flow temperature drops below the set limit temperature (T-MF1). It is switched off again when the return flow temperature exceeds the set limit temperature by the Hysteresis (HYST MF 1).

32 = Direct heating circuit

Is activated by means of a short circuit at the sensor input of relay 1 and switches the heating circuit pump ON. There is an after-run after the sensor short circuit is cancelled. The HS obtains a set temperature value from the parameter " T-MF1 ".

FUNC RELAY 2 (function selection relay 2)

00 = no function

01 = Header pump

ON: When heat is requested by a consumer
OFF: Without consumer heat request

If at least one consumer in the system requests heat the pump is switched on. The after-run function is effective after the heat generator is switched on.

02 = Circulation

Switching the relay according to the circulation program

03 = Booster pump

ON: In the event of a heating request from an internal consumer OFF: Without internal consumer heating request A pump after-run occurs.

05 = Pump heat generator 1

When using the controller to control two heat generators the relay may be used to control the heat generator pump for heat generator 1.

(Relay switches with burner relay 1; run-down = 5 min)

06 = Pump heat generator 2

When using the controller to control two heat generators the relay may be used to control the heat generator pump for heat generator 2.

(Relay switches with burner relay 2; run-down = 5 min)

Installation		
Designation	Value range	Default
SCREED	00, 01 (OFF/ON)	00 = OFF
SCREED PROGR	See explanation!	
RETURN	Exit level using 	

! Start day is not included:
The screed program starts with the "Day 1" temperature setting and switches to "Day 1" at 00.00 hrs and then to the next day at 00.00 hrs and so on. The current day is marked with an "x" in the "SCREED PROGR" program.

! After the function has been cancelled/terminated the controller continues heating using the set operating mode. If no heating is required, set the operating mode to  = Standby / OFF.

Screed program

SCREED (activation of screed drying process)

The screed program can be used for function heating in accordance and for heating freshly laid screed ready for flooring.







! The screed drying process can only be performed for the mixer circuits of the HS controller.

After starting, the program runs through the set flow temperatures. The integrated mixer circuits control to the set flow temperature. The heat generator provides this temperature irrespective of the operating mode that has been selected. This is marked in the standard display by the entry "SCREED" and a display of the current flow temperature.

The freely adjustable program runs for a maximum of 28 days. The flow temperatures can be set to a value of between 10°C and 60°C for each day. The entry "----" stops the program (also during operation for the following day).

DAY	1	2	3	4	5	6	7	8	9	10	11	12	13	14	15	16	17	18	19	20	21	22	23	24	25	26	27	28
VT	25	25	25	55	55	55	55	25	40	55	55	55	55	55	55	55	55	55	55	40	25	---	---	---	---	---	---	---
=>																												



SCREED PROGR (Program setting)

 => Screed program;  Select day;  => Activate adjustment date;  Set flow temperature;
 => Save setting;  Select next day or exit screed program using "RETURN" + .

Hot water			
Designation	Value range	Default	IV
DHW RELIEF	00, 01 (OFF/ON)	01 = ON	
PARALLEL DHW *)	00, 01, 02, 03	01	
T-HS DHW	00K – 50K	20 K	
HYST DHW	5K – 30K	5 K	
DHW FOLLOWUP	00 min – 30 min	00 min	
THERM INPUT	00, 01 (OFF/ON)	00 = OFF	
WALL HUNG	00, 01 (OFF/ON)	00 = OFF	
LOAD THROUGH	00, 01 (OFF/ON)	00 = OFF	
RETURN	Exit level using 		

DHW RELIEF(Charge pump lock)

The charging pump is not switched until the heat generator temperature exceeds the storage tank temperature by 5K. It is switched off when the heat generator temperature drops below the storage tank temperature. This prevents the storage tank from being cooled by the heat generator when hot water preparation starts.

 Hinged cover OPEN → search for level to the right with ,
open with 

*) Function with [CoCo2 index \geq 03] => 02 = 03;
with CoCo1/CoCo2 (< index 03) => 01 = 00 and 02 = 03

PARALLEL DHW (Pump parallel running)

00 => **Hot water priority operation**: The heating circuits are blocked during hot water preparation. The mixers close and the heating circuit pumps switch off.

01 => **HW partial priority**: The heating circuits are blocked during hot water preparation. The mixers close and the heating circuit pumps switch off. The mixer circuits are enabled again when the heat generator has reached the temperature of hot water set temperature + heat generator superheating [T-DHW + T-HS DHW]. If the heat generator temperature drops below the enable temperature by the switching hysteresis [HYST DHW], the mixer circuits are blocked again.

02 => **Pump parallel running**: Only the direct heating circuits are blocked during hot water preparation. The mixer circuits continue to be heated. The hot water preparation is extended by this function.

03 => **Pump parallel running also for the direct heating circuit**: During hot water preparation all heater circuits continue to be heated. The hot water preparation is extended

by this function. When the heat generator temperature exceeds the maximum flow temperature of the direct heating circuit by 8K, the heating circuit pump for this circuit is switched off (overheating protection). The heating circuit pump has already been switched on again when the heat generator temperature drops below the temperature [maximum flow temperature + 5K].

T-HS DHW

(Heat generator superheating during hot water preparation)

Heat generator set temperature during hot water preparation = Hot water set temperature + T-HS DHW

! The heat generator must be run at a higher temperature during hot water preparation so that the hot water temperature in the storage tank can be reached via the heat exchanger.

HYST DHW (Hot water charging hysteresis)

Hot water preparation is started when the temperature of the hot water storage tank drops below the temperature setting by the hysteresis [HYST DHW]. The hot water preparation stops when the storage tank reaches the temperature setting (the temperature setting is set to 65°C during hot water short time heating operation).

DHW FOLLOWUP (pump run-down time)

00 min => Standard function: The charging pump continues to run for 5 minutes after the burner has switched off. If heat is requested by a heating circuit the run-down is cancelled.

The charge pump blocking kicks in and can also cause the run-down function to be cancelled.

greater than 00 min => The charge pump runs down by the set time when storage tank charging is complete. The after-run can only be cancelled by means of the activated charge pump blocking.

THERM INPUT (storage tank with thermostat)

00 => Hot water preparation via storage tank sensor

01 => Hot water preparation via thermostat: The hot water preparation is started by a short circuit at the storage tank sensor connecting terminals. It stops when the short circuit is removed.

WALL HUNG (for modulating HG)

Heat generator set temperature during hot water preparation = Storage tank actual temperature + T-HS DHW

With this function the exhaust gas losses occurring during hot water preparation can be reduced with modulating heat generator using the adapted heat generator set temperature.

LOAD THROUGH

T-DHW = Temperature of hot water storage tank at outlet area

Storage tank charging:

ON: $T\text{-DHW} < T\text{-DHW DES} - \text{HYST DHW}$

OFF $T\text{-DHW B} > T\text{-DHW DES}$

Charging the storage tank is stopped when the storage tank set temperature is measured at the lower sensor.

! If this function is activated, the auxiliary functions with sensor integration ("EXPERT => INSTALLATION", parameter "FUNC RELAY 1" => 20-32) are not possible

The parameters in this level change in accordance with the heating circuit function that has been selected [HC FUNCTION]

Heating circuit I / II			
Designation	Value range	Default	IV
HC FUNCTION	00 - 04	00	
PUMP MODE	00 - 03	00	
MIXER OPEN (not for HW circuit)	5-25	18	
MIXER CLOSE (not for HW circuit)	5-25	12	
See following pages for continuation			

HC FUNCTION (heating circuit function selection)

If this parameter is modified the controller is restarted. "RESET" briefly appears in the display.

! The special functions (02, 03, 04) must be configured for heating circuit 2 if a normal heating circuit (00, 01) is additionally used in the device.

00 => Standard heating circuit

01 => Control to fixed flow temperatures

During the heating periods (see heating program) the heating circuit is operated with a fixed preset flow temperature

[T-FLOW DAY], and during reduced mode operation with a fixed preset flow temperature [T-FLOW REDUC] accordingly.

02 => Swimming pool control (only for heating circuit II)

This function can be used to heat a swimming pool. The mixer controls the flow temperature for the swimming pool heat exchanger. The swimming pool water temperature sensor is connected to the room sensor connection for the heating circuit (see FBR).

[Plug III; 1+2]

The flow temperature control operates like normal room control [ROOM INFL].

The set value for the water temperature can be entered in the user area of the associated heating circuit level [T-POOL 1/2/3]. The heating program operates. No heating takes place during the reduction period (frost protection only).

The water temperature and the current set value are displayed in the display level [POOL-TEMP/RATED POOL-T].

03 => Hot water circuit

This function can be used to operate additional hot water circuits. The heating circuit flow sensor is located in the hot water storage tank.

The hot water temperature set value can be entered in the user area of the associated heating circuit level [T-DHW 1/2/3]. The heating program for heating circuit acts as an enable program for the storage tank. The storage tank set value is set to 10°C during the reduction period.

The heat generator controller's hot water priority function can be used.

! If an optional storage tank flow temperature sensor and lower storage tank sensor is connected, the function for storage tank charging via an external heat exchanger with storage tank through-charging capability is activated automatically.

04 => Return flow temperature increase via mixer motor

The heating circuit flow sensor is used as a heat generator return flow sensor. The mixer motor controls to the heating circuit set value for 24 hours [MIN T-FLOW].

Installation tip: Mixer motor OPEN => heat generator flow is fed into the return (=> return flow temperature increase) Mixer motor CLOSED => heating circuit return is passed through. When the mixer motor is open, it must be ensured that there is circulation through the heat generator (heat generator pump).

PUMP MODE (pump operating mode)

The circulation pumps are switched off if heating is not required. The mixer motors are closed at the same time => "The heating circuit is switched off".

(Switch on with 1K hysteresis)

The setting affects the weather-controlled deactivation. Additionally, the thermostat-controlled deactivation takes effect if room regulation is activated (ROOM INFL > 0).

- Room temperature > room set value + 1K

00 => Standard circulation pump control

Heating time:

- Outside temperature > room set value + 1K

Reduction time:

ROOM INFL =0:

- The switch-off occurs during the transition to reduction operation.
- Restart: Room temperature < room set value The pump runs continuously after switching on.

ROOM INFL = "--,":

- Flow temperature setting < 20°C.

01 => Pump switching in accordance with heating limits

Heating time:

- Outside temperature < daytime set heating limit + 1K

Reduction time:

- Outside temperature < set night-time heating limit + 1K

02 => Pump switching in accordance with heating program

Heating time:

- Pump is ON; Heat circuit is enabled

Reduction time:

- Pump is OFF; Heat circuit is blocked

03 => Continuous operation

The runs continuously for 24 hrs.! The heating circuit is permanently enabled.

MIXER OPEN (mixer dynamics when opening)

Speed setting at which the mixer motor opens when a control difference occurs. The control difference at which the mixer motor opens without interruption is entered in Kelvin.

! Small values cause the mixer motor to adjust quickly and can lead to oscillation.

MIXER CLOSED (Mixer dynamics when closing)

Speed setting at which the mixer motor closes when a control difference occurs. The control difference at which the mixer motor closes without interruption is entered in Kelvin.

! Small values cause the mixer motor to adjust quickly and can lead to oscillation.

Heat circuit I/II			
Designation	Value range	Default	IV
MAX T-FLOW	20°C - 110°C	80°C	
MIN T-FLOW	10°C - 110°C	10°C	
T-FROST PROT	----; (-15)°C – (5)°C	0°C	
T-OUT DELAY	0:00 – 24:00	0:00	
SLOPE OFFSET	0K – 50K	5 K 1)	
B-HEAT SINK	00, 01 (OFF/ON)	01 = ON	
RETURN	Exit level using 		

1) Controller .0324-P and .0634-P = 35K

MAX T-FLOW(maximum flow temperature)

The measured temperature setting for the heating circuit flow is limited to the maximum flow temperature setting (overheating protection).

△ The heating circuit pump of the direct heating circuit is only switched off if the temperature of the heat generator exceeds the maximum flow temperature by 8K. The heating circuit pump is switched on again when the temperature of the heat generator drops below the temperature [maximum flow temperature + 5K].

MIN T-FLOW(minimum flow temperature)

The measured temperature setting of the heating circuit flow is increased to the minimum flow temperature setting (e.g. with air heating).

T-FROST PROT (frost protection temperature)

If the outside temperature drops below the programmed value, the system switches to frost protection mode (pumps are switched on).

"----" Frost protection mode is deactivated!

T-OUT DELAY (outside temperature delay)

The selected outside temperature delay must be matched to the type of construction of the building. In the case of heavy structures (thick walls), a long delay must be selected since a change in outside temperature affects the room temperature later accordingly. With light structures (walls have no storage effect) the delay should be set (0 hrs.).

SLOPE OFFSET (heating slope distance)

The heat generator temperature that is required for a mixer circuit is calculated by adding the calculated temperature setting for the heating circuit flow to the heating slope distance. The heating curve distance compensates for sensor tolerances and heat loss up to the mixer.

B-HEAT SINK (circuit enable)

00 => OFF

01 => The heating circuit can be used by higher-order functions (e.g. cooling function of a heat generator to protect from overheating; heat removal during service mode) as a heat sink/consumer. The heating circuit is heated at the maximum flow temperature setting for the duration of the function.

Part 3: General function description

Heat circuit control

Weather-dependent control

The heat generator or flow temperature is determined via the set heat slope to suit the measured outside temperature in such a way that the set value for the room is approximately set if the heating system is configured correctly.

=> Exact setting of the heat slope is extremely important for weather-dependent control.

The circulation pump is controlled weather-dependently. The circulation pump is switched on if there is a heating demand and in Frost-protection mode.

Room sensor influence

The current room temperature can be included in computation of the required flow temperature via a present room temperature sensor.

The influence factor (parameter list) can be set between 0 (fully weather-dependent regulation) and 20 (room temperature regulation with minimal outdoor temperature influence). Position "----" deactivates room temperature control. Positions "----" and "0" indicate differences for demand-dependent circulation pump control.

Hot water generation

The programmed hot water temperature is stabilised by switching the hot-water cylinder charging pump and the burner. Storage tank charging starts when the storage tank temperature drops below the temperature setting by 5K. Storage tank charging stops when the temperature setting is reached.

Frost protection function

The frost protection circuit prevents the heating system from freezing by automatically switching heating operation on.

Outdoor sensor frost protection

If the measured outside temperature drops below the set frost protection temperature the room temperature setting is set to 5°C for the relevant heating circuit. The heating circuit is enabled:

- the pumps are switched on
- the heat request is sent to the heat generator

"----" => outdoor sensor frost protection deactivated

The function stops when the outside temperature increases to 1K above the frost protection temperature setting.

Heat generator frost protection

The heat generator frost protection is activated when the heat generator temperature drops below 5°C. The heat generator is switched on until the heat generator temperature exceeds the "MINIMUM HEAT GENERATOR TEMPERATURE".

Flow or storage tank sensor frost protection

The sensor frost protection is activated when the flow or storage tank temperature drops below 7°C. Only the relevant pump is switched on.

The sensor frost protection is deactivated when the flow or storage tank temperature increases to above 9°C.

Frost protection via room sensor

If the room temperature drops below 5°C the frost protection function is activated.

The room temperature setting for the relevant heating circuit is set to 5°C. The heating circuit is enabled:

- the pumps are switched on
- the heat request is sent to the heat generator

eBUS burner controls

The controller supports the operation of burner controls via the implemented eBUS. The unit is connected by means of the connector VII (FA eBUS).

Heat request: Controller => Burner / FA

05h07h [in data byte 7 = Process water desired value the burner must not interpret bit 7] additionally

05h01h [in data byte 3 the collector temperature is transmitted (instead of hot water desired temperature)]

Data/Status: Burner/FA => Controller

05h03h

Requirements for operation:

The burner control unit (FA) must transmit a valid eBUS message.

The eBUS supply must be activated if the burner does not also supply the BUS => Expert/ Installation (tap without information => Test function with and without eBUS supply)

EEPROM check

Every 10 minutes, a check is conducted automatically in order to establish whether the settings of the controller lie within the specified limits. If a value is found to be out-of-range, it is substituted by the related default value. The range transgression is indicated by the blinking \triangle and the error number 81.

In this case, the user should check the important settings of the controller. The warning symbol is cleared after the unit is restarted (RESET).

Circulation pump control

Switched according to heating requirement

Demand-dependent circulation pump control (automatic summertime switchover) switches the circulation pumps off if there is no heating demand. The mixers are closed at the same time.

Conditions for switch-off:

Room temperature-dependent control

The room temperature exceeds the set desired temperature.

Weather-dependent control

Outside temperature exceeds room temperature set value or flow temperature set value drops below 20°C.



If the room temperature factor is "0", the pump continues to run during the reduced operation period after a one-off heating demand.

Delayed pump switch-off

In the case of switch-off of the circulation pumps, the circulation pumps are not switched off until 5 minutes later if one of the burners was on during the last 5 minutes before the switch-off instant.

Pump blocking protection

The controller effectively prevents blocking of the pumps if they are not switched on for long periods. The integrated protection function switches on all pumps which have not been in operation during the past 24 hours for 5 seconds at 12.00 h ours every day.

Mixer motor blocking protection

If the mixer motor has not moved for 24 hours it is fully opened at approximately 03:00 hrs. (once only). The heating circuit pump is switched off during this time. The maximum flow temperature is monitored. Cancelled at maximum flow temperature – 5K.

Part 4: Installation and Start-up

Installation

Assembly / Dismantling

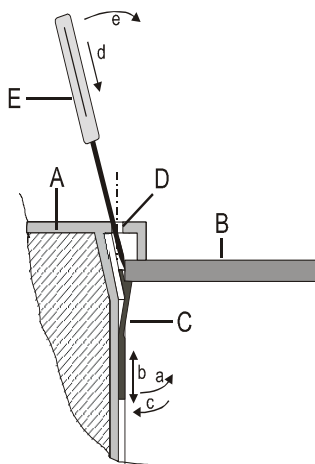

Sketch showing basic mode of operation:

- A Controller, side view, cutaway view
- B Control panel plate
- C Mounting clamp
- D Unlocking holes (see Chapter Changing set values)
- E Sharp-pointed tool

Installing the controller:

1. Set the mounting clamp to the wall thickness of the control panel (at the left and right-hand side of the unit):
 - a. Pull the mounting clamp at the low away from the controller wall (toothing).
 - b. In this condition, slide the mounting clamp down or up until the distance from the edge of the unit corresponds to the thickness of the control panel wall.
Detent position 1 \cong 0.5-1.0 mm wall thickness
Detent position 5 \cong 5.0 mm wall thickness
 - c. Press the mounting clamp against the controller wall at the low.

2nd Press the controller into the control panel recess and check that it is firmly secure. If the controller wobbles: Remove the controller and move the mounting clamps up.

Removing the controller:

- ⚠ Disconnect the unit from the power supply before removing it.
- d) Insert a sharp-pointed tool at an angle with respect to the exterior wall into one of the unlocking holes (the tool must be slid between mounting clamp and control panel wall).

- e) Lever the tool with respect to the unit exterior wall. This causes the mounting clamp to release the control panel wall.

Raise the unit slightly at the corresponding side and repeat the procedure on the other side of the unit.

The unit can now be removed.

Connecting instructions

- ⚠ The controller is designed for an operating current of 230 V AC at 50 Hz. The burner contact is potential-free and must always be connected in series with the mechanical boiler thermostat (if present).

- ⚠ Attention: Bus lines and sensor lines must be laid separately, away from mains cables!

! After connecting or modifying the connections of sensors and remote controls the controller must be briefly switched off (mains switch/fuse). The function of the controller is reconfigured in accordance with the connected sensors the next time the controller is switched on.

Notes on connecting heat generators via the CAN BUS (also with CoCo, e.g. CAN/OT)

If the controller is not used solely as a mixer extension, i.e. service water sensor or collector sensor [connector 1; PIN 6-8] is installed or 3rd heating circuit [RELAY FUNC 1 =

32] is activated, then the collector sensor [connector 1; PIN 7+8] must be short-circuited by a bridge if a heat generator is operated via the CAN BUS interface. This also applies if an OpenTherm HS is connected via a CoCo CAN/OT.

Note for installation in connection with digital room device

When installing a digital room device, the heating circuit-specific set values are adjusted at the room device. These values are automatically faded out inside the controller.

! If during operation the digital room device is separated from the BUS for a longer time period (>5min), the heating controller will continue to work with its own set values.

In order to avoid damages in case of errors - for deviations from relevant set values (such as maximum flow temperature for floor heaters) - we suggest the following procedure:

1. Installing the new heating controller
2. Set all values for heating controller
3. Install one digital room device
4. Set all values for digital room device

System diagram

Maximum configuration:

HS regulation (2-stage)

Hot water generation

2 mixed heating circuits, remote-controlled via BUS or

1 mixed heating circuit & Fixed value / Pool regulation

Return increase/Solar/Solid fuel

Circulation pump

!

Depending on controller type, only partial functions are assigned for your controller.

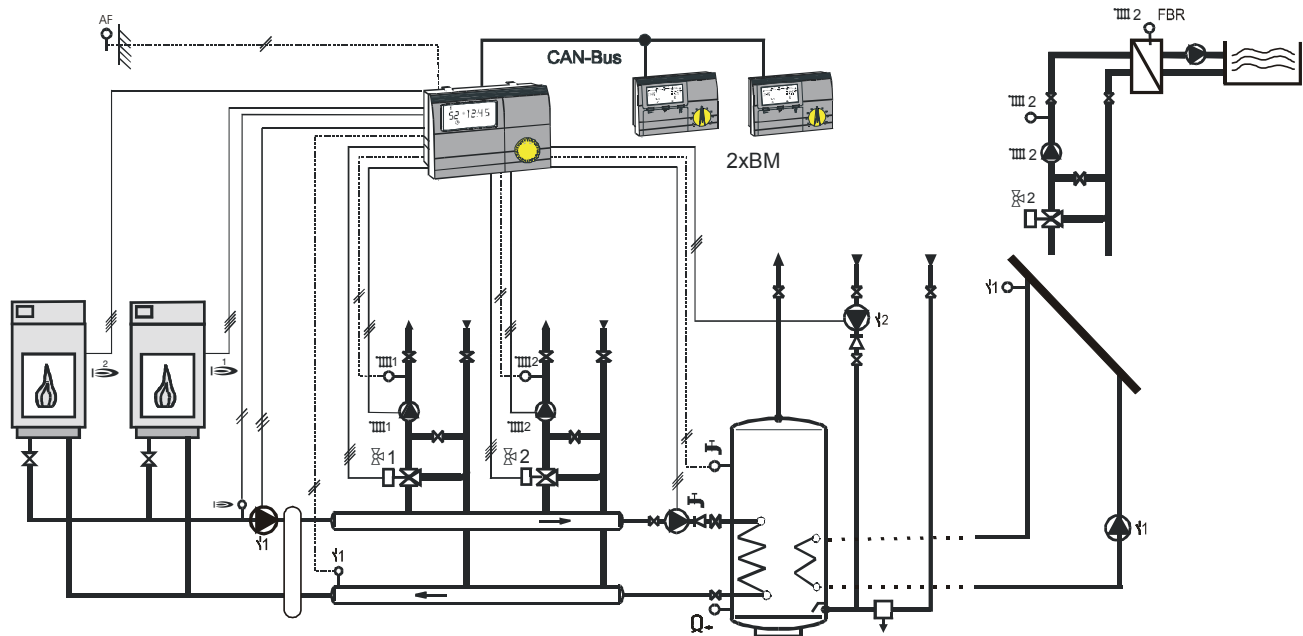

System diagram with HS via eBUS

Maximum configuration:

HS regulation modulating

Hot water generation

2 mixed heating circuits, remote-controlled via BUS or

1 mixed heating circuit & Fixed value / Pool regulation

Return increase/Solar/Solid fuel

Circulation pump



Depending on controller type, only partial functions are assigned for your controller.

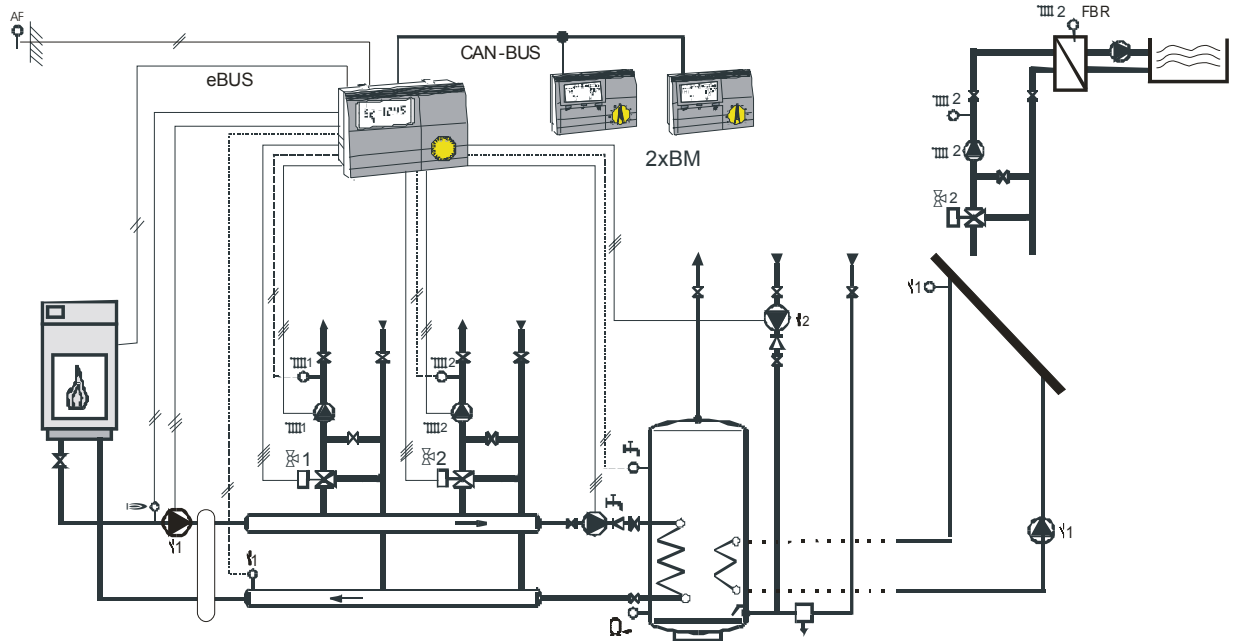

Electrical connection

Version 1

230V~; Relay switching capacity 2(2)A, 250V~

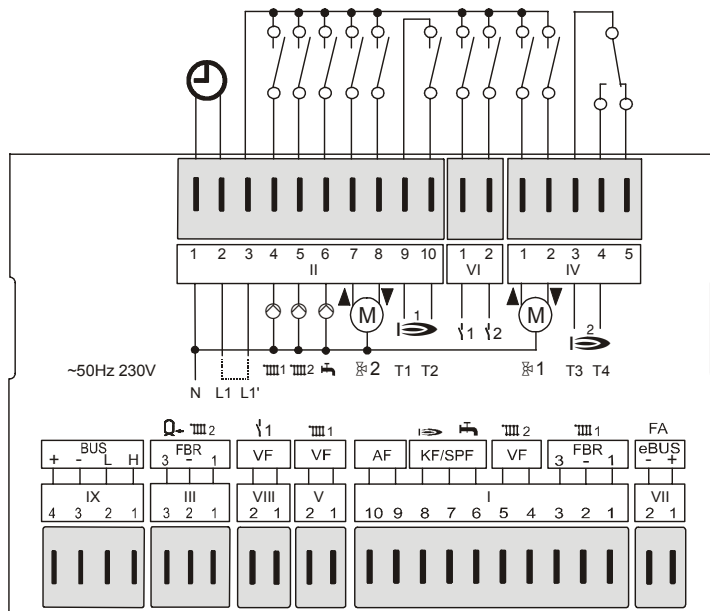

Displayed connection is the maximum version .0634

Terminal wiring

- VII (1+2): eBUS (HS) or eBUS - DCF
- I (1-3): FBR2 (FBR1) for heating circuit 1
- I (4+5): Flow sensor, heating circuit 2
- I (6+7): Storage tank sensor
- I (7+8): Boiler sensor
- I (9+10): Outdoor sensor
- V (1+2): Flow sensor, heating circuit 1
- VIII (1+2): Sensor multifunction relay 1
- III (1-3): FBR2 (FBR1) for heating circuit 2
- III (2+3): Lower buffer sensor
- IX (1+2): Data line CAN bus
- IX (3+4): Power supply CAN bus
- II (1): Neutral conductor, mains
- II (2): Power supply, unit
- II (3): Power supply, relay
- II (4): Pump, heating circuit 1
- II (5): Pump, heating circuit 2
- II (6): Storage tank pump
- II (7): Mixer open, heating circuit 2
- II (8): Mixer closed, heating circuit 2
- II (9+10): Burner stage 1 / heat generator 1
- VI (1): Multifunction relay 1
- VI (2): Multifunction relay 2
- IV (1): Mixer open, heating circuit 1
- IV (2): Mixer closed, heating circuit 1
- IV (3+4): Burner stage 2 / heat generator 2

Version 2

230V~; Relay switching capacity 2(2)A, 250V~

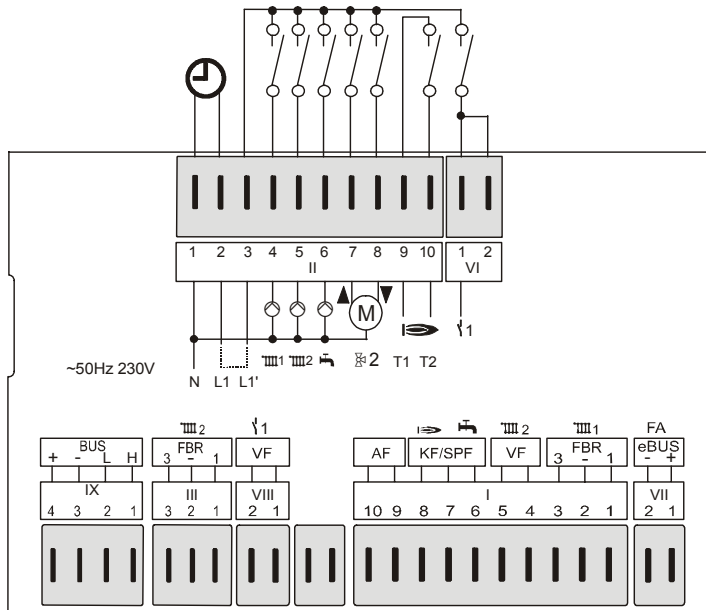

Terminal wiring

- VII (1+2): eBUS (HS) or eBUS - DCF
- I (1-3): FBR2 (FBR1) direct heating circuit
- I (4+5): Flow sensor mixer circuit
- I (6+7): Storage tank sensor
- I (7+8): Boiler sensor
- I (9+10): Outdoor sensor
- VIII (1+2): Sensor multifunction relay \downarrow 1
- III (1-3): FBR2 (FBR1) for mixer circuit
- III (2+3): Lower buffer sensor
- IX (1+2): Data line CAN bus
- IX (3+4): Power supply CAN bus

- II (1): Neutral conductor, mains
- II (2): Power supply, unit
- II (3): Power supply, relay
- II (4): Boiler circuit pump
- II (5): Pump, mixer circuit
- II (6): Storage tank pump
- II (7): Mixer OPEN
- II (8): Mixer CLOSED
- II (9+10): Heat generator/Burner
- VI (1 / 2): Multifunction relay \downarrow 1

Displayed connection is the maximum version .0324

Power terminal assignments

Plug 2 [III]

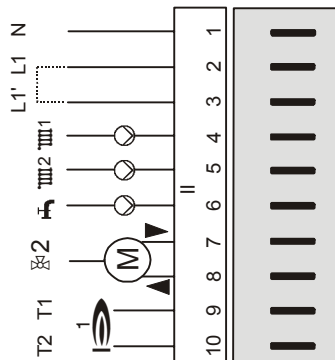

- N: Neutral conductor, mains
- L1: Power supply, unit
- L1': Power supply to relay
- HK 1: heating circuit pump HK 1
- HK 2: heating circuit pump HK 2
- Storage tank charging pump
- Mixer open, heating circuit 2
- Mixer closed, heating circuit 2
- Burner stage 1
- Burner stage 1

Plug 6 [VI]

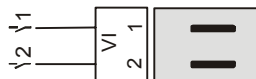

- Multifunction relay 1
- Multifunction relay 2

Plug 4 [IV]

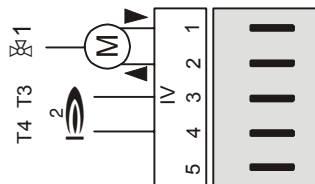

- Mixer open, heating circuit 1
- Mixer closed, heating circuit 1
- Burner stage 2
- Burner stage 2
- No function

Sensor terminal assignments

Connector 7 [VII] with eBUS

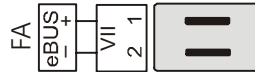

- Pin 1: eBUS (HS) or eBUS - DCF
- Pin 2: eBUS (ground)

Connector 1 [I] for HC as HW circuit

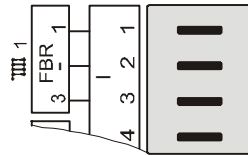

- Pin 1: Storage tank sensor flow
- Pin 2: (ground)
- Pin 3: Storage tank sensor lower

Connector 1 [I]

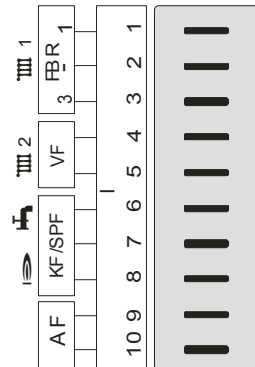

- Pin 1: FBR heating circuit 1 (room sensor)
- Pin 2: FBR heating circuit 1 (ground)
- Pin 3: FBR heating circuit 1 (set value/operating mode)
- Pin 4: Flow sensor, heating circuit 2 (ground)
- Pin 5: Flow sensor, heating circuit 2
- Pin 6: Waste water sensor
- Pin 7: Waste water and boiler sensor (ground)
- Pin 8: Boiler sensor
- Pin 9: Outdoor sensor (ground)
- Pin 10: Outdoor sensor

Connector 5 [V]



Pin 1: Flow sensor, heating circuit 1 (ground)
 Pin 2: Flow sensor, heating circuit 1

Connector 8 [VIII]

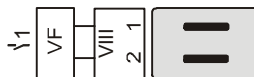

Pin 1: Sensor, multifunction relay 1 (ground)
 Pin 2: Sensor multifunction relay 1

Connector 3 [III] (without solar integration)

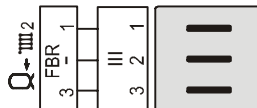

Pin 1: FBR heating circuit 2 (room sensor)
 Pin 2: FBR heating circuit 2 (ground)
 Pin 3: FBR heating circuit 2 (set value/operating mode)

Connector 3 [III] (with solid fuel/ solar integration)

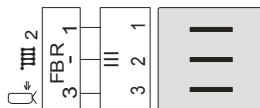

Pin 1: Room sensor (heating circuit 2)
 Pin 2: Lower buffer sensor and room sensor (ground)
 Pin 3: Lower buffer sensor (T-BUFFER B) at inlet area for solar/solid fuel

Connector 3 [III] for HC as HW circuit

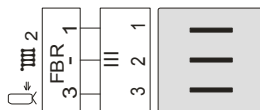

Pin 1: Storage tank sensor flow
 Pin 2: (ground)
 Pin 3: Storage tank sensor lower

Connector 9 [IX]

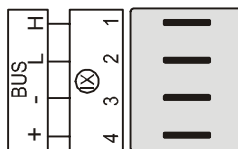

CAN Bus Pin 1 = H (Data)
 CAN Bus Pin 2 = L (Data)
 CAN Bus Pin 3 = - (ground, Gnd)
 CAN Bus Pin 4 = + (12V supply)

Remote controls

The operator module Merlin BM, BM 8, Lago FB

(Only for controller models with CAN-Bus connection)

Electrical connection: Connector IX; 1-4

The E6 permits connection of an operation-control module BM for each heating circuit via a bus line. The operation-control module allows various operation-control functions and monitoring functions for the system values to be relocated to the main controlled zone – i.e. the living room. This achieves maximum comfort and convenience. Please refer to the technical description of the BM for a precise description of the overall scope of functions.

- Display of the system parameters
- Entry of the heating circuit parameters
- Room temperature control
- Automatic adaptation of the heat slope (not Lago FB)

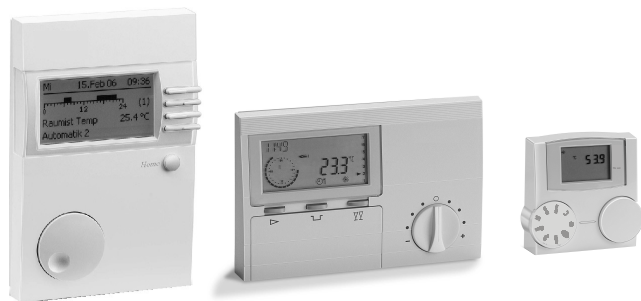

Remote control FBR2

Electrical connection: Connector I; 1-3 and connector III; 1-3

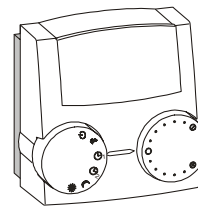

- Rotating switch for modifying room temperature setting
Adjusting range: (± 5 K)
- Room control via the integrated room sensor
- Rotating switch for selecting operating mode
 - ☐ Standby/OFF (frost protection only)
 - ⌚₁ Automatic mode (according to timer program 1 in controller)
 - ⌚₂ Automatic mode (according to timer program 2 in controller)
 - 🌙 24-hour night operation (reduction temperature)
 - ☀️ 24-hour daytime operation (comfort temperature)
 - 🚿 Summer mode (heating OFF, hot water only)

Depending on the version, your FBR supports a portion of the following operating modes.

- !** The heating program switch at the controller must be set to ⌚.

Installation location:

- In reference / main living room of the heating circuit (on an inside wall of the room).
- Not in the vicinity of radiators or other heat dissipating units.
- Any, if the room sensor influence is switched off.

Installation:

- Remove cap from underside of pedestal.
- Secure the base at the installation location.
- Connect the electrical connection cables.
- Press the cap back on.

Sensor resistances FBR

Temperature	FBR1 terminals 1-2 switch in position 	FBR2 terminals 1-2 Room sensor
+10 °C	680 Ω	9.950 Ω
+15 °C	700 Ω	7.855 Ω
+20 °C	720 Ω	6.245 Ω
+25 °C	740 Ω	5.000 Ω
+30 °C	760 Ω	4.028 Ω

DCF receiver

Electrical connection: Connector VII; 1,2

The controller can evaluate a eBUS DCF receiver on the eBUS FA-Terminals.

If the DCF receiver is connected, the controller time is brought up to date daily at 03.02 and additionally 5 minutes after switching on the voltage.

If the time does not correct itself after the specified period, select a different location for the DCF (e.g. a different wall) and restart the controller (switch voltage-free once).

PC

All system-specific parameters can be set and interrogated using the *ComfortSoft* parameterisation software. The parameters can be saved, displayed graphically and evaluated on the PC at predefined intervals. To connect to a PC you need the optical adapter or CoCo PC active, which also supports the sending of error messages by SMS and the remote interrogation of controller data.

Maximum delimiter

If a maximum delimiter is required it must be connected between the heating circuit pump and the pump controller switch output.

Connector I, terminals 4 and 5

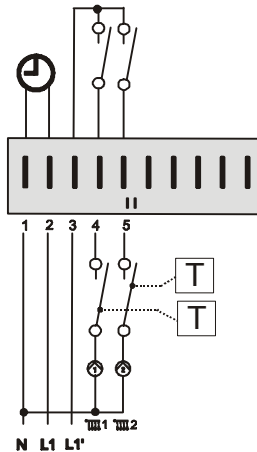

Telephone switch

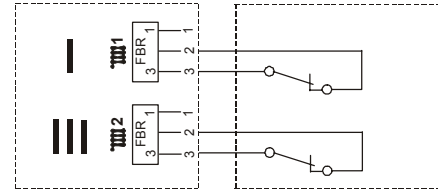

The heating system can be switched to Heating mode * with a telephone switch. The connection terminals of the controller for the remote control FBR (see connection diagram) are used for installation. As soon as a short circuit is detected at terminals 2 and 3 of the corresponding connector, the assigned heating circuit switches to heating operation. Additionally, the hot water preparation is activated. (Boiler controller) When the short-circuit is eliminated, the controller resumes heating on the basis of the set heating program.

- ⚠ If the heating circuit is controlled remotely by an operating module, the telephone switch must be connected at the operating module.

Sensor values / characteristic curve

Temperature	5KOhm NTC	1KOhm PTC
-60°C	698961 Ω	470 Ω
-50°C	333908 Ω	520 Ω
-40°C	167835 Ω	573 Ω
-30°C	88340 Ω	630 Ω
-20°C	48487 Ω	690 Ω
-10°C	27648 Ω	755 Ω
0°C	16325 Ω	823 Ω
10°C	9952 Ω	895 Ω
20°C	6247 Ω	971 Ω
25°C	5000 Ω	1010 Ω
30°C	4028 Ω	1050 Ω
40°C	2662 Ω	1134 Ω
50°C	1801 Ω	1221 Ω
60°C	1244 Ω	1312 Ω
70°C	876 Ω	1406 Ω
80°C	628 Ω	1505 Ω
90°C	458 Ω	1607 Ω
100°C	339 Ω	1713 Ω
110°C	255 Ω	1823 Ω
120°C	194 Ω	1936 Ω

5KOhm NTC: AF, KF, SPF, VF**1KOhm PTC: AFS, KFS, SPFS, VFAS**

The controller can be operated with 5KOhm NTC (standard) or 1KOhm PTC sensors. The sensor type is selected in the start-up level during start-up.

The start-up level is displayed when the operating cover is opened after the supply voltage has been switched on (once only). It can be reactivated again by briefly switching the supply voltage off.

The sensor switchover affects all sensors.

Exceptions:

- Attaching an analogue remote control is detected automatically. This means that the previous and new versions can be connected to the controller [connector I; 1-3 and connector III; 1-3].
- The controller has a facility for connecting a room sensor to terminals [connector I; 1+2 and connector III; 1+2] and performing room temperature-dependent control. In this case only a 5KOhm NTC sensor can be used, irrespective of the sensor type that has been selected.

Outdoor sensor AF (AFS)

Installation location:

- Wherever possible, on a northerly or north-easterly wall behind a heated room
- Approx. 2.5 m above ground
- Not above windows or ventilation shafts

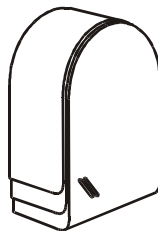

Installation:

- Detach the cover.
- Attach the sensor with the supplied screw.
-

Boiler sensor KF (KFS)

Installation location:

- Immersion sleeve for thermometer, temperature controller and boiler sensor in heating boiler

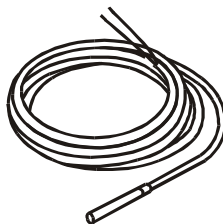

Installation:

- Slide the sensor as far as possible into the immersed pipe.

Flow sensor VF (VFAS)

Installation location:

- In the case of boiler control, in place of the boiler sensor KF as close as possible behind the boiler on the heating flow pipe
- In the case of mixer operation  approx. 0.5 m behind the circulation pump

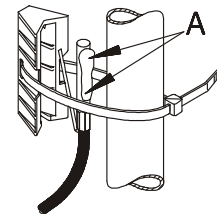

00990-01

Installation:

- Thoroughly clean the flow pipe.
- Apply heat conductive paste (A)!!
- Secure sensor with stretch band.

Storage tank sensor SPF (SPFS)

Installation location:

- In the immersed pipe of the hot-water cylinder tank (generally on the front face of the tank)

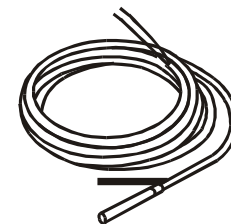

Installation:

- Slide the sensor as far as possible into the immersed pipe.

! The immersed sleeve must be dry.

Commissioning

Commissioning level	
All the values in this level must be entered in sequence without interruption	
☒ Open level, ⌚ adjust value, ☒ save value and activate next value	
GERMAN	Set language
TIME	Set current time: 1. Minute => ☒ => 2. Hour
YEAR	Set current date
MONTH	Set current date
DAY	Set current date
BUS ID 1 (see p. 68)	Enter heating circuit number"1": 00-15 => Standard 01
BUS ID 2 (see p. 68)	Enter heating circuit number"2": 00-15 => Standard 02
5K SENSORS	00 = 5KOhm NTC sensor 01 = 1kOhm PTC sensor code no. required; after input, there is a restart of the controller

Commissioning procedure

1. Please read this guide carefully before commissioning
2. Fit controller, make electrical connections and switch on heat generator and supply voltage
3. Wait until standard display appears on controller
4. Open hinged operating cover

When the hinged operating flap is opened for the first time after switching on, the " SETUP " is shown on the display.

5. ☒ Start SETUP
6. ⌚ Set value
7. ☒ Save value and next value
8. Close hinged operating flap (end of SETUP)
9. Move program switch to required operating mode, e.g. automatic 1 (see page 8)

BUS- ID (Heating circuit number):

The heating circuits are sequentially numbered starting with "01". heating circuit numbers must not be assigned twice. Please only use "00" for replacement controllers (see page 68).

System bus

The heating system

This controller can be expanded in a modular fashion using additional modules that are connected via the integrated bus. In its maximum configuration, the system can be used to control the following heating system components

- 1-8 Heat generator (modulating or switching)
- 1-15 Mixed weather-dependent heating circuits
- 0-15 Room controller (digital or analogue)
- 1 Solar system (2 collectors, 2 storage tanks)
- 1 Solid fuel heat generator

The various components are simply coupled to the system bus. The modules log on to the system automatically and search for their communication partners via the defined BUS ID (heating circuit number or heat generator number).

Bus ID

For mixer motor controllers and control units

The bus ID (00-15; expert level parameter) is used to number the heating circuits in the system. Each operating module and each mixer motor module is given the number of the assigned heating circuit as its bus ID.

- Heating circuit numbers (00-15) may not be assigned twice.
- Heating circuit numbers 00 and 01 may not be used simultaneously.
- The heating circuits are sequentially numbered starting with "01".
- Please only use heating circuit number 00 for replacement controllers if "00" was used in the replaced controller.

Pre-settings

heating circuit 1 → 01
heating circuit 2 → 02

- !** After setting all the bus ID's the system must be reenergised (once only).



Error messages

Error no.	Error description
Communication error	
E 90	ID 0 and 1 on bus. Bus IDs 0 and 1 may not be used simultaneously.
E 91	Bus ID used. The set bus ID is already in use by another device.
Internal error	
E 81	EEPROM error. The invalid value has been replaced with the default value \triangle Check parameter values!
Sensor error (break/short)	
E 69	Flow sensor HC2
E 70	Flow sensor HC1
E 75	Outdoor sensor
E 76	Storage tank sensor
E 77	Boiler sensor
E 79	Sensor multifunction relay 1
E 80	Room sensor HC1 / Storage tank sensor flow HC1
E 83	Room sensor HC2 / Pool sensor / Storage tank sensor flow HC2
E 131	Storage tank sensor lower HC1
E 134	Multifunction relay BUFFER Lower (Solar / Solid fuel) / Storage tank sensor lower HC2

If a fault or error occurs in the heating system, you will see a blinking warning triangle (\triangle) and the related error number on the controller display. Please refer to the table below for the significance of the displayed error code.

The system must be restarted after a fault has been remedied => RESET.

RESET: Brief device shut-off (mains switch). Controller restarts, reconfigures itself and continues to operate with the values that have already been set.

RESET+ : Overwrite all settings with default values (except language, time and sensor values). The additional button () must be pressed when the controller is switched on (mains on) until "EEPROM" appears in the display.

Troubleshooting

General

If your system malfunctions you should first check that the controller and the control components are correctly wired.

Sensors:

The sensors can be checked in the "General/Service/Sensor test" level. All the sensors that are connected must appear in this level with plausible measurements.

Actuators (mixer motors, pumps):

The actuators can be checked in the "General/Service/Relay test" level. All relays can be individually switched using this level. This makes it easy to check whether these components have been correctly connected (e.g. mixer motor direction of rotation).

BUS Connection:

In control devices with connection to

Mixer motor => Communication symbol appears in standard display ("◆" or "⊗" depending on version)

Boiler controller => Outside temperature and boiler temperature display (see "Display/Installation")

In boiler controller with connection to

Control unit => Room temperature displayed and current room temperature setting blanked out "----"

(see "Display/heating circuit")

In mixer motor expansion controllers with connection to

Boiler controller => Display of the outside temperature and the heat generator temperature

(see "Display/Installation")

Control unit => Room temperature displayed and current room set temperature blanked out "----"

(see "Display/Heating circuit")

In case of communication problems

Check connecting cables: Bus lines and sensor lines must be laid separately, away from mains cables! Poles switches?

Check bus feed: There must be at least 8V DC between the "+" and "-" terminals of the BUS connector (connector IX, terminals 3+4). If you measure a lower voltage, an external power supply must be installed.

Pumps do not switch off

Check manual / automatic switch => Automatic

Pumps do not switch on

Check operating mode => Standard ☺ (test ☼)

Check time and heating program => Heating time

Check pump switching => Type of pump switching

Standard => Outside temperature > Room temperature

setting? Heating limits => Outside temperature >

Valid heating limit?

Room control => Room temperature >

Temperature setting + 1K

Technical data

Burner does not switch of at correct time

Check minimum heat generator temperature and type of minimum delimiter => Protect from corrosion

Burner will not switch on

Check set temperature of heat generator => The set temperature must be above the current heat generator temperature.

Check operating mode => Standard ☺ (test ☼)

Check BOB-VALUE

The current temperature of the heat generator's solid fuel is greater than the HS1 set temperature.

Supply voltage to IEC 38	230 V AC ± 10%
Power consumption	Max. 8 VA
Switching capacity of the relays	250 V 2(2) A
Maximum current on terminal L1'	10 A
Enclosure to EN 60529	IP 40
Safety class II to EN 60730	Totally insulated
Switch panel installation in acc. with DIN IEC 61554	Recess 138x92
Power reserve of the timer	> 10 hours
Permitted room temperature during operation	0 to 50°C
Permitted room temperature during storage	- 20 to 60 °C
Permissible humidity non condensing	%95 r.H.
Sensor resistances	NTC 5 kΩ (AF,KF,SPF,VF)
Tolerance in ohms	± -1% at 25°C
Temperature tolerance	+/- 0.2K at 25°C
	PTC 1010Ω (AFS,KFS,SPFS,VFAS)
Tolerance in ohms	± -1% at 25°C
Temperature tolerance	+/- 1.3K at 25°C

Malfunctions due to improper operation or settings are not covered by the warranty.