

# Sensor AF, AFS, KF/SPF, KFS/SPFS, VF, VFAS, KLF, KLFS

Technical Information · GB

**10.6.4** Edition 08.10

- Temperature sensor for use in all areas of heating, solar, solid fuel, buffer, heat pump and cooling systems
- A variety of sensing elements are available: 1 k $\Omega$  PTC, 5 k $\Omega$  NTC and Pt 1000



**krom**  
**schroder**



## Table of contents

Sensor AF, AFS, KF/SPF, KFS/SPFS, VF, VFAS, KLF, KLFS. . . . .	1
Table of contents . . . . .	2
1 Application . . . . .	3
2 Function . . . . .	4
2.1 Electrical connection . . . . .	4
3 Choice . . . . .	5
4 Technical data . . . . .	6
4.1 Data table . . . . .	6
4.2 Dimensions . . . . .	7
4.2.1 Outside sensor AF, AFS. . . . .	7
4.2.2 Contact flow temperature sensor VF, VFAS, VF 1000, Boiler / Storage sensor KF/SPF, KFS/SPFS, SPF1000, collector sensor KLFS7	
4.2.3 Collector sensors KLF, KLF1000 . . . . .	7
4.3 Resistance values . . . . .	8
4.3.1 Resistance diagrams . . . . .	9
Feedback . . . . .	10
Contact . . . . .	10



## 1 Application

The temperature sensor can be used in all types of heating, solar, solid fuel, buffer, heat pump and cooling systems. The following temperature sensors are available:

- Outside sensor AF/AFS for measuring the outside temperature.
- Boiler sensor KF/KFS for sensing the heat source temperature.
- Contact flow temperature sensor VF/VFAS for measuring the flow and return flow temperatures.
- Storage sensor SPF/SPFS for measuring the hot-water temperature.
- Collector sensor KLF, KLFS for measuring the medium temperature on the solar collectors.

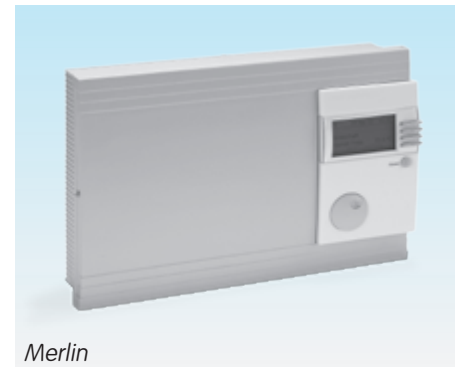

## 2 Function

Three different sensing elements are used: 1 k $\Omega$  PTC, 5 k $\Omega$  NTC or Pt 1000. The electrical resistance changes with changing temperatures in all types.

For the PT 1000, the nominal resistance value of 1000  $\Omega$  is reached at 0 °C. The changes in resistance at different temperatures are defined in EN 60751. This ensures that the accuracy of measurement is retained when temperature sensors are replaced.

The 5 k $\Omega$  NTC (negative temperature coefficient) is a thermistor whose resistance decreases with increasing ambient temperatures.

The opposite applies to the 1 k $\Omega$  PTC (positive temperature coefficient resistor) where the resistance value decreases with decreasing temperatures.

With the 5 k $\Omega$  NTC and 1 k $\Omega$  PTC respectively, the nominal resistance is reached at 25 °C.

The accuracy of measurement in these types is also great enough for them to be replaced without needing to change anything on the heating controller see [Technical data – p. 6].

## 2.1 Electrical connection

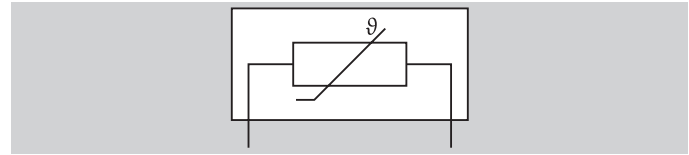

Connection for two conductors, permutable

Temperature sensor with lead: Core cross-section 2x 0.34 mm<sup>2</sup> with wire end sleeves, outside sensor: Screw terminal for cable cross-sections up to 1.5 mm<sup>2</sup>

### 3 Choice

The different temperature sensor types can be used for the following series of controllers:

Controller series	1 k $\Omega$ PTC: AFS, VFAS, KFS/SPFS, KLFS	5 k $\Omega$ NTC AF, VF, KF/ SPF, KLF	Pt 1000 VF1000, SPF1000, KLF1000
K1	●		
E25	●		
Lago	●	●	
E8	●	●	
Merlin	●	●	●*
Lago SD			●

Never mix types of temperature sensors. Please refer to the respective technical instructions for further details.

\* Pt 1000-temperature sensor only as multifunction sensor.

## 4 Technical data

Response time (63 % of the final value):  
 ≤ 16 s in medium that is in motion.

Seal:

IP protection class based on tests in accordance with  
 EN 60529, see data table.

Material:

Housing, cable: see data table,

Sleeve: stainless steel,

Spring: stainless spring steel.

Insulation and electric strength:

Insulation resistance: sleeve to the electrical connections  
 ≥ 10 MΩ,

Electric resistance: Sleeve to the electrical connections  
 DC 500 V.

Accuracy / Deviation of measurement:

1 kΩ, PTC at 25 °C: 1010 Ω ±1 % corresponds to ±1.3 K,  
 within the temperature range from -40 to +25 °C: ±2.74 K,  
 within the temperature range from +25 to +120 °C: ±4.33 K.

5 kΩ, NTC at 25 °C: 5 Ω ±1 % corresponds to ±0.2 K,  
 within the temperature range from -40 to +25 °C: ±0.5 K,  
 within the temperature range from +25 to +155 °C: ±1.8 K.

Pt 1000 at 0 °C: 1000 Ω ±0.12 % in accordance with  
 EN 60751, Class B.

### 4.1 Data table

Type	L [m]	Ød [mm]	l [mm]	F [mm]	Dia- gram	Spring	Seal	Protection class	Material	Pull-off force [N]	Temperature range [°C]
<b>1 kΩ PTC</b>											
AFS	–	–	–	–	A	–	–	IP 44	ASA, grey	–	-40–+60
VFAS	3	6	50	50	B	yes	clamped	IP 67	PVC, grey	30	+5–+95*
KFS/SPFS	3	6	50	50	B	yes	clamped	IP 67	PVC, grey	30	+5–+95*
KLFS	3	6	50	50	B	yes	clamped	IP 67	Silicone, red	30	-30–+120
<b>5 kΩ NTC</b>											
AF	–	–	–	–	A	–	–	IP 44	ASA, grey	–	-40–+60
VF	3	6	50	50	B	yes	clamped	IP 67	PVC, grey	30	+5–+95*
KF/SPF	3	6	50	50	B	yes	clamped	IP 67	PVC, grey	30	+5–+95*
KLF	2	6	45	–	C	no	roller burnished	IP 65	Silicone, red	50	-30–+155
<b>Pt 1000</b>											
KLF1000	2	6	50	50	B	yes	clamped	IP 67	Silicone, red	30	-30–+180
VF1000	3	6	50	50	B	yes	clamped	IP 67	PVC, grey	30	+5–+95*
SPF1000	3	6	50	50	B	yes	clamped	IP 67	PVC, grey	30	+5–+95*
KLF1000	1.5	5.5	36	–	C	no	roller bur- nished	IP 67	Teflon, white	25	-30–+250

\* Short term +105 °C.

## 4.2 Dimensions

### 4.2.1 Outside sensor AF, AFS

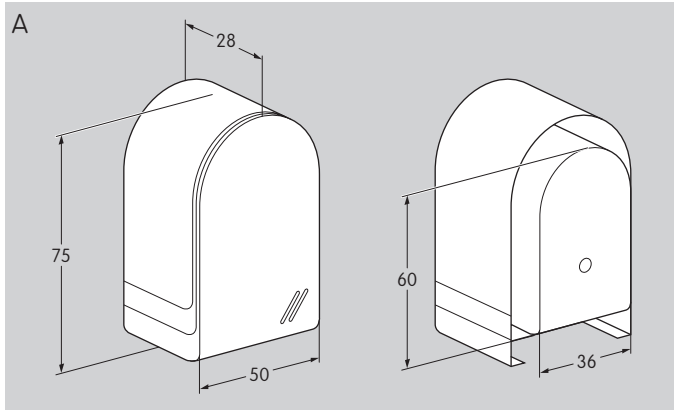

The outside sensors are supplied with installation material consisting of dowel and wood screw.

### 4.2.2 Contact flow temperature sensor VF, VFAS, VF 1000, Boiler / Storage sensor KF/SPF, KFS/SPFS, SPF1000, collector sensor KLFS

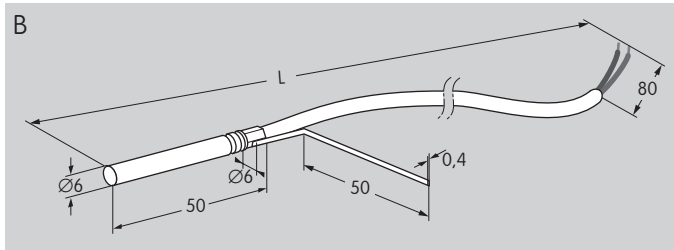

The contact flow temperature sensors are supplied with installation material consisting of press-on cap, retaining strap and heat conductive paste.

### Installation VF/VFAS

For heating system control, the VF/VFAS flow sensors are installed instead of the KF boiler sensor as close as possible to the rear of the boiler on the heater flow pipe.

For mixer operation, the VF/VFAS flow sensors are installed approx. 0.5 m downstream of the circulation pump.

The flow sensors are easily fastened using the retaining strap and the the press-on cap included in delivery.

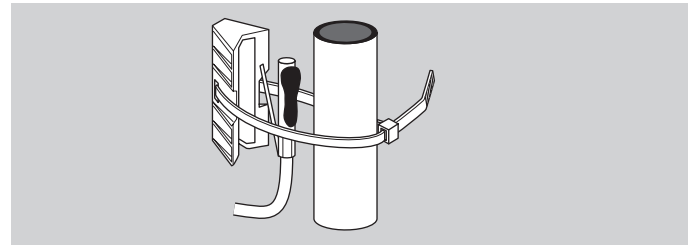

### 4.2.3 Collector sensors KLF, KLF1000

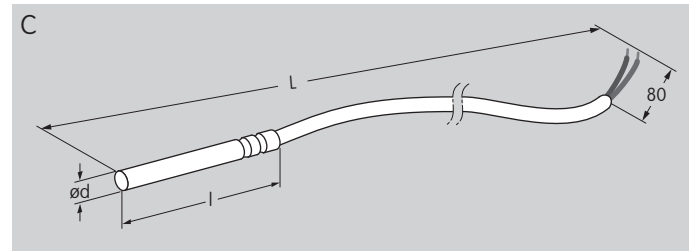

### 4.3 Resistance values

Temperature [°C]	1 kΩ PTC AFS, VFAS, KFS/ SPFS, KLFS [Ω]	5 kΩ NTC AF, VF, KF/SPF, KLF [Ω]	Pt 1000 VF1000, SPF1000, KLF1000 [Ω]
-40	573	167835	
-35	601	121098	
-30	630	88340	882
-25	660	65121	901
-20	691	48487	921
-15	722	36447	941
-10	755	27648	960
-5	789	21157	980
0	823	16325	1000
5	859	12697	1019
10	895	9952	1039
15	932	7857	1058
20	971	6247	1077
25	1010	5000	1097
30	1050	4028	1116
35	1091	3265	1136
40	1134	2662	1155
45	1177	2183	1174
50	1221	1800	1194
55	1266	1493	1213
60	1312	1244	1232
65	1358	1041	1251
70	1406	876	1270
75	1455	740	1289
80	1505	628	1309
85	1555	535	1328
90	1607	458	1347
95	1659	393	1366
100	1713	339	1385
105	1767	294	1404

Temperature [°C]	1 kΩ PTC AFS, VFAS, KFS/ SPFS, KLFS [Ω]	5 kΩ NTC AF, VF, KF/SPF, KLF [Ω]	Pt 1000 VF1000, SPF1000, KLF1000 [Ω]
110	1823	255	1422
115	1879	222	1441
120	1936	194	1460
125	1995	170	1479
130	2054	150	1498
135	2114	132	1517
140	2175	117	1535
145	2237	104	1554
150	2300	92	1573
155	2364	82	1591
160			1610
165			1629
170			1647
175			1666
180			1684
185			1703
190			1721
195			1740
200			1758
205			1776
210			1795
215			1813
220			1831
225			1850
230			1868
235			1886
240			1904
245			1922
250			1941



### 4.3.1 Resistance diagrams

1 k $\Omega$ , PTC: AFS, VFAS, KFS/SPFS, KLFS

5 k $\Omega$ , NTC: AF, VF, KF/SPF, KLF

Pt 1000

VF1000, SPF1000, KLF1000

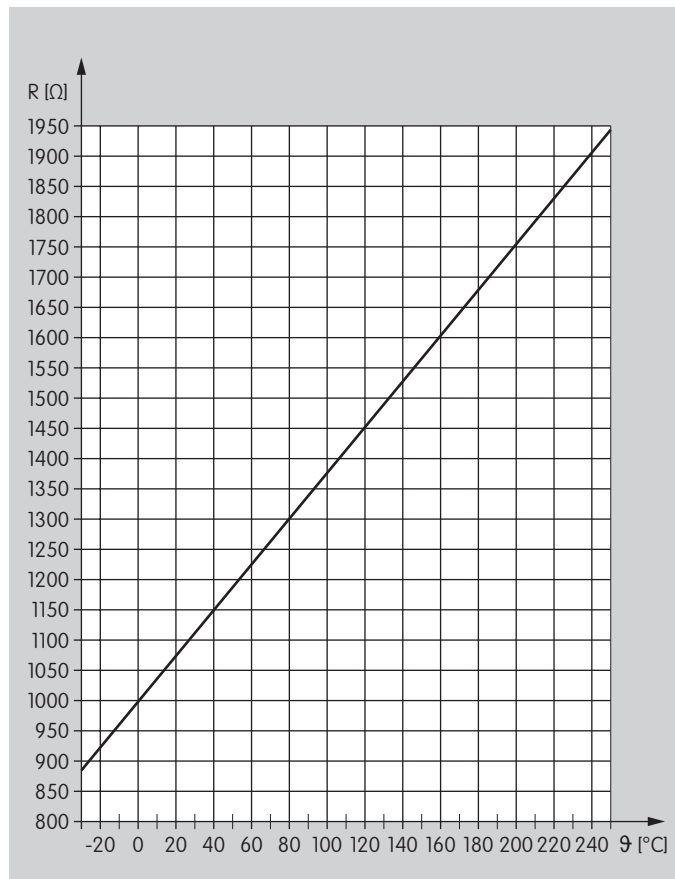
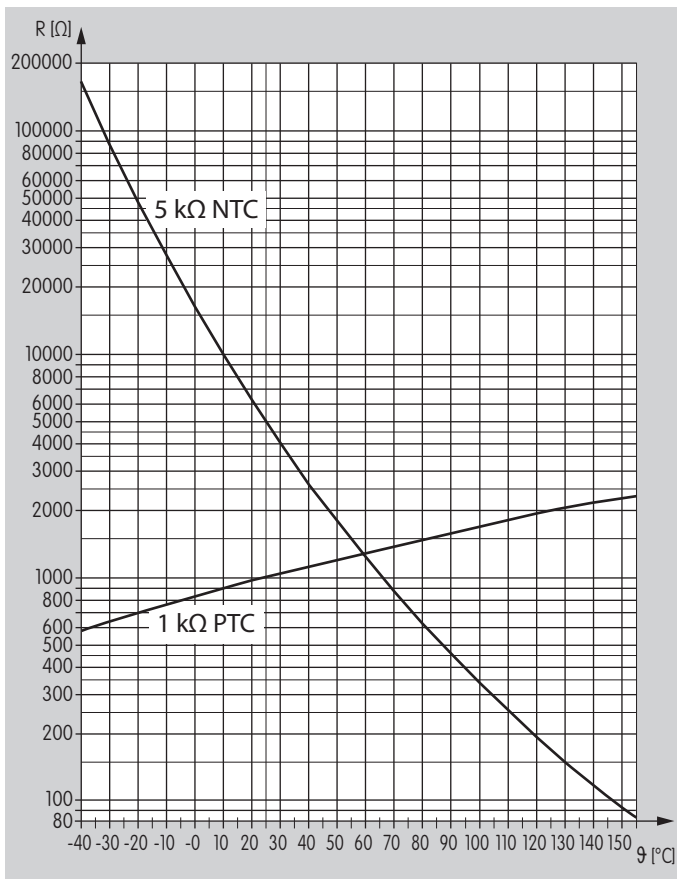

## Feedback

Finally, we are offering you the opportunity to assess this “Technical Information (TI)” and to give us your opinion, so that we can improve our documents further and suit them to your needs.

### Clarity

- Found information quickly
- Searched for a long time
- Didn't find information
- What is missing?
- No answer

### Comprehension

- Coherent
- Too complicated
- No answer

### Scope

- Too little
- Sufficient
- Too wide
- No answer

### Use

- To get to know the product
- To choose a product
- Planning
- To look for information

### Navigation

- I can find my way around
- I got “lost”
- No answer

### My scope of functions

- Technical department
- Sales
- No answer

### Remarks

(Adobe Reader 7 or higher required)

## Contact

Elster GmbH  
 Geschäftssegment Comfort Controls  
 Kuhbrückenstraße 2–4 · 31785 Hameln  
 Deutschland  
 T +49 5151 9572-0  
 F +49 5151 9572-100  
 vertrieb.cc@kromschroeder.com  
 www.comfort-controls.de  
 www.elster.com

The current addresses of our international agents are available on the Internet:  
[www.comfort-controls.de](http://www.comfort-controls.de) →  
 Dealer Search

We reserve the right to make technical modifications in the interests of progress.  
 Copyright © 2007–2010 Elster Group  
 All rights reserved.